

# DA200

High Performance AC Servo System



# Contents

Introduction.....	2
Servo product family.....	3
Outstanding product performance.....	4
Abundant practical functions.....	5
Intelligence.....	7
User-friendly operation software.....	9
Application cases.....	11
Servo drive models.....	14
Servo drive technical parameters.....	17
Servo system configuration table.....	19
Servo motor models.....	20
Servo motor technical parameters.....	21
Servo motor installation dimensions.....	22
Servo motor torque-speed characteristics.....	25
Servo motor power cable models.....	27
Servo motor power cable wiring.....	28
Servo motor encoder cable models.....	29
Servo motor encoder cable wiring.....	30
Connection ports.....	31
System wiring.....	35
Standard wiring diagram.....	36
Ordering guide for servo system.....	40
Other INVT industrial control products.....	41
One-stop service & marketing network.....	42

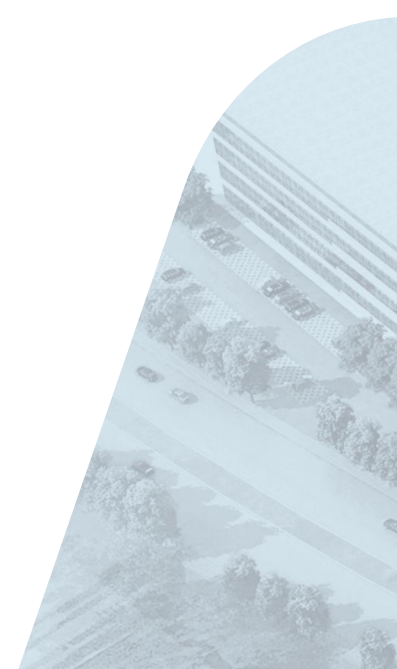



# **/ Introduction**

DA200 series high performance AC servo system is an INVT flagship product that is developed according to market needs and aims at assisting customers in industry. Applying the leading control performance to actual industrial needs achieves a perfect combination of the servo system and application environment.

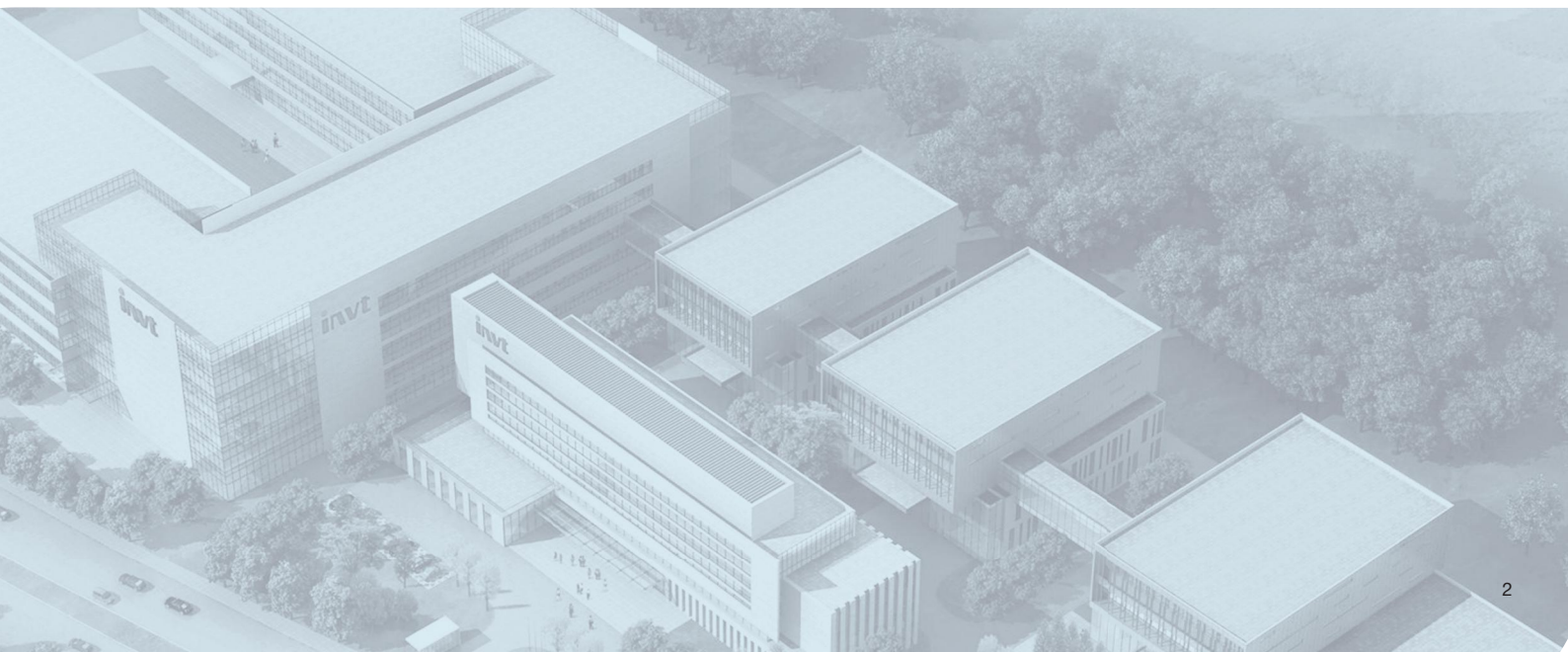

# Servo product family

Comprehensive product series support various networks and matching devices, facilitating the construction of required systems.

## Drive layer



DA180 basic AC servo system



DA200 high performance AC servo system



DA300 intelligent AC servo system



DA212 dual-axis AC servo system



MH860A electrohydraulic servo system



DL310 DC Low voltage servo drive

## Execution layer



Small power servo motor



Medium power servo motor

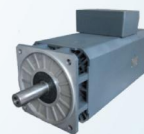

Synchronous motor

# Outstanding product performance

## Industry-leading speed response

The speed response frequency can reach 2.0kHz, improving the processing rate and reducing the tuning time, with the full use of advanced mechanical performance.

3times  
of a common  
product  
**2kHz**

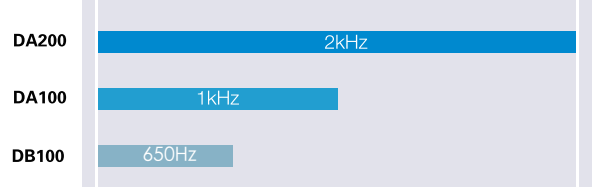

## Accurate positioning

The support for the 23-bit encoder with the 0.15 arcsecond resolution achieves accurate positioning, stable machining at low speed, and bright and clean machined surface. The use of an absolute encoder ensures the motor will not lose the position origin in case of power-off.

64times  
of a common  
product  
**23bit**

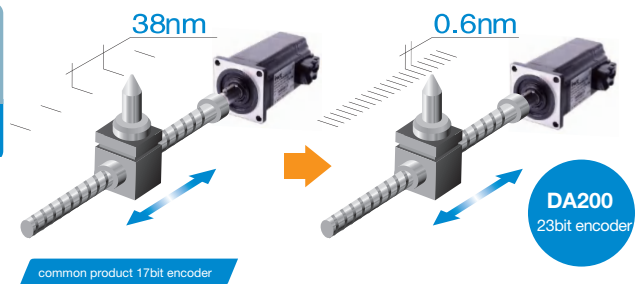

Applicable to scenarios that require absolute positions with high rigidity, such as robot, LED optical splitter, high speed drilling center, warp knitting machine, engraving and milling machine, turning and milling combined machine, and tool servo.

## Enriched communication interfaces

Networking based on Modbus, CANopen, PROFINET, or EtherCAT achieves remote, multi-shaft, high-speed, synchronous control.

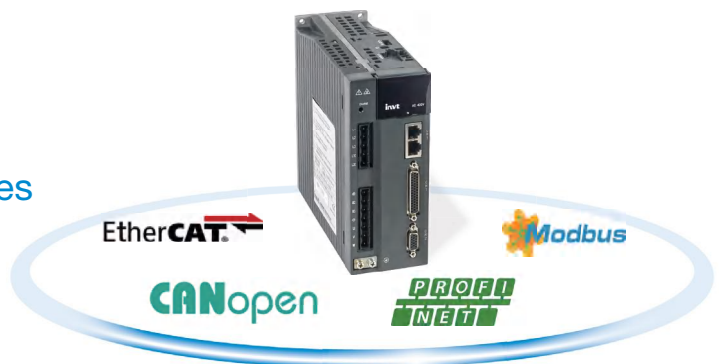



# Abundant practical function

## Fully-closed loop control

Support for external connection to an encoder or grating ruler installed at the load end, implementing fully-closed loop control, reducing back clearance impact caused by mechanical drive, and improving machine-end positioning accuracy.

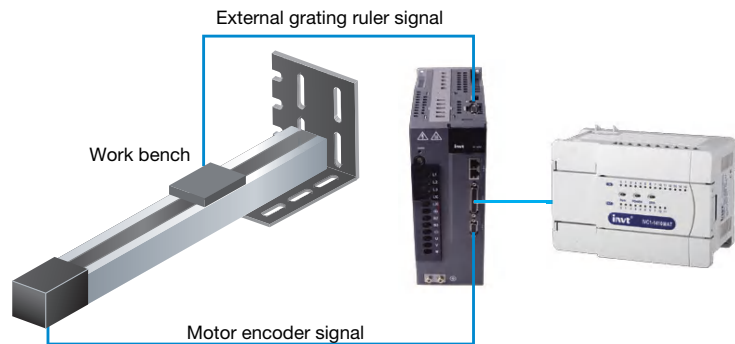

## Internal position control

Achieving 128-segment internal position control with combination of input terminal commands (external I/O or bus control). For simple motion control, the internal program design can help simplify the PLC and optimize the external configuration plan.

PtP0.00	Control word of segment 00	Setting range	Default	Unit	Control mode
		0~0x7FFFFFFF	0	-	P

**Overall description**

Data bit	Name	Function
Bit0~3	MODE	PTP running mode.
Bit4~7	OPT	Segment attribute.
Bit8~11	ACC	ACC/DEC time index.
Bit12~15	SPD	Target speed index.
Bit16~19	DLY	Delay time index.
Bit20~23	CYL	Segment execution cycles.
Bit24~30	JMP	Jumps to the next segment.

**Description for MODE**

MODE	Meaning
0	Stops after executing the current segment.
1	Jumps to the next segment after executing the current segment.
2	Stops after circular execution. If CMD is 1, circulation is invalid.
3	Jumps to the next segment after circular execution. If CMD is 1, circulation is invalid.

**Description for OPT**

Data bit	Name	Function
Bit4	INS	Insertion. The current segment has the execution termination privilege over segments that are being executed or not executed.
Bit5	OVL	Overlap. The current and next segments can be overlapped for execution.
Bit6~7	CMD	Position command type. 0: incremental position; 1: absolute.

## Electronic cam

- The cam profile can consist of 3600 points.
- Automatic smooth interpolation can be implemented between two points of a curve, making mechanical motions more smooth.
- The ServoPlover software supports cam planning and setting.
- Applicable to master/slave application scenarios such as flying and rotary shears.

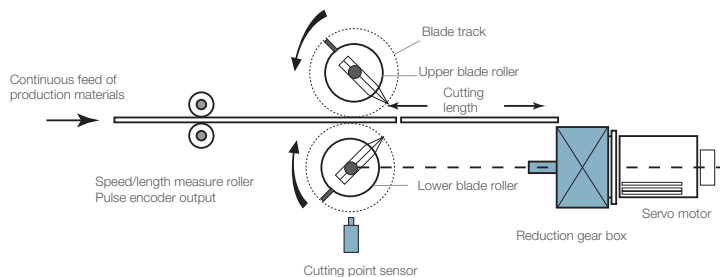

## Linear motor control

Support for control on linear motors, including those without magnetic sensors. After magnetic pole detection is enabled, the motor executes minor FWD-and-RVS motions for detection. After the detection is completed, the servo is ready for motion control.

### Function description

To work with 3rd-party linear motors, position sensor signals should be 5V differential ABZ signals. The maximum allowed pulse signal frequency of the drive is single-channel 3MHz or orthogonal 12MHz. Magnetic sensor signals (optional) support differential input.

### Features

If a linear motor without magnetic sensors is used, it executes first power-on or using magnetic pole detection signals. The minor FWD-and-REV motions for the pole detection after the rotor moving range is within 2mm (configurable). The internal stalling protection function ensures linear motor safety. The ASR bandwidth can reach 1kHz or higher, and the position tuning time is less than 5ms.

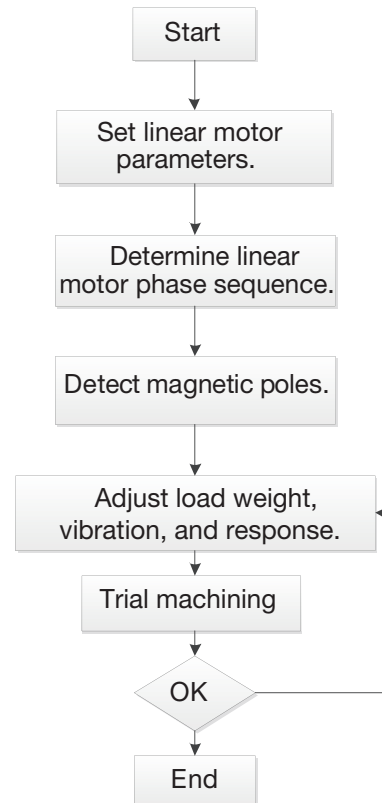

## Load inertia identifying

Providing online and offline inertia identifying. Automatically identifying gain parameters in the system reduces system tuning time.

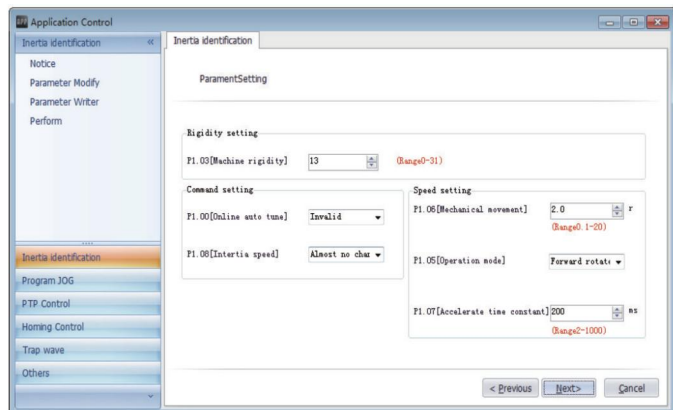

# Intelligence

## Automatic/manual notch filter

Simplified notch filter setup achieves automatic vibration detection without vibration frequency. Abnormal noise and vibration caused by mechanical devices can be greatly reduced by using a notch filter.

DA200 series product carries four notch filters, each of which has frequency designated to 50Hz – 5000Hz and adjustable depth. (Two of the filters can be automatically set.)

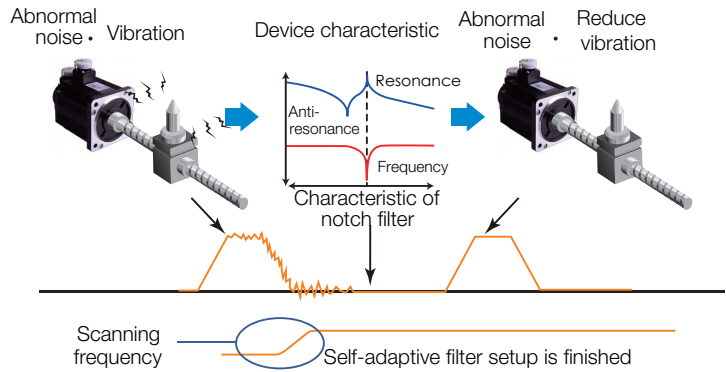

## Low frequency vibration control

Special low frequency vibration control algorithms can be used to effectively control low frequency mechanical resonance and control oscillation at long swing arm end.

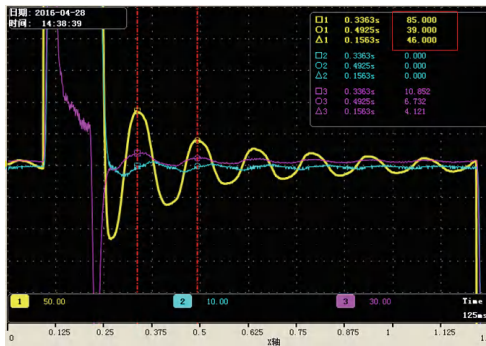

Vibration control is not conducted

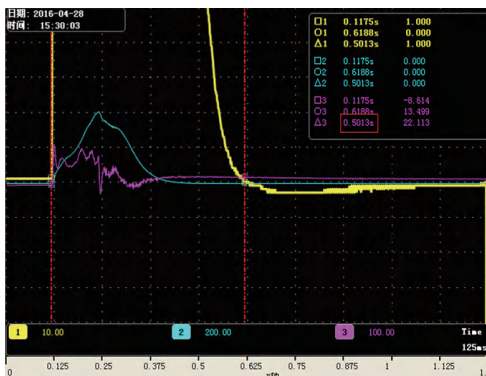

Vibration control is conducted

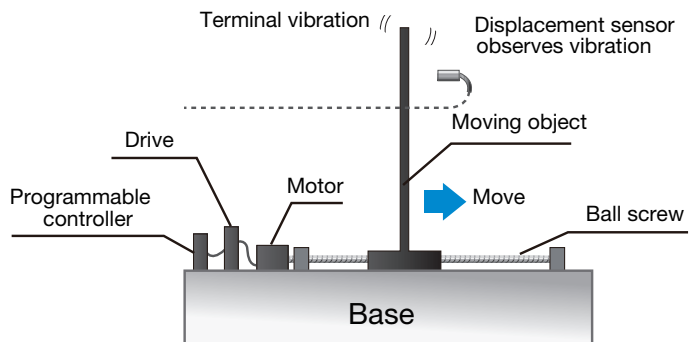



## ■ Gantry synchronism

Support for dual-shaft alignment and synchronous following. The controller conducts synchronous control automatically without the complicated upper PC control. When position deviation exceeds the allowed value, an alarm is reported to stop system running.

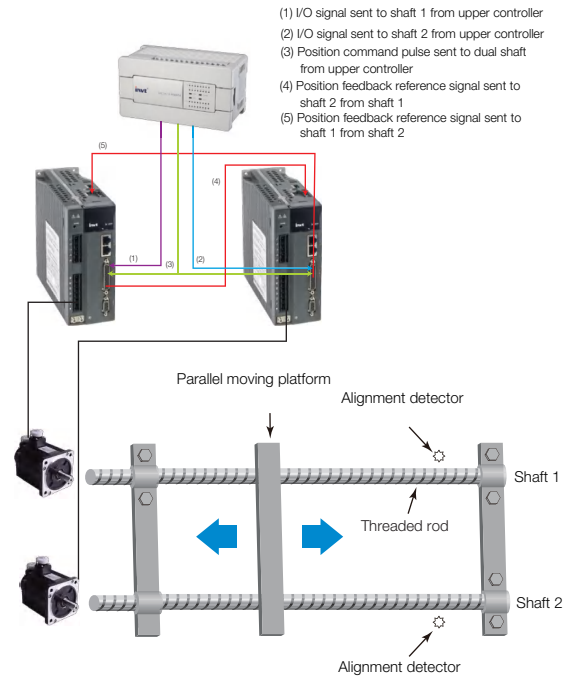
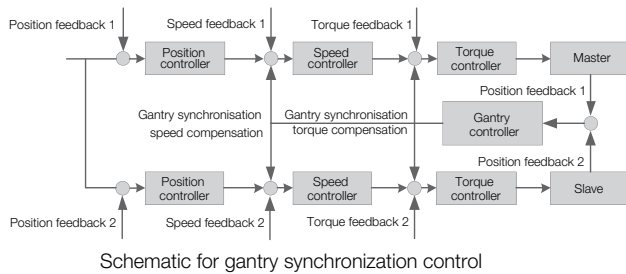

## ■ Disturbance control

Equipped with the disturbance control function to compensate for the control performance impact caused by load disturbance and parameter changes, enhancing system robustness and greatly improving command following performance.

## ■ Friction torque compensation

Equipped with the friction torque compensation function to reduce the impact caused by static friction during motor commutation and improve command following performance at low speed running.

## ■ Simple gain adjusting and switching

The speed and position loop gains and filter time constant can be automatically adjusted by setting rigidity levels, effectively reducing commissioning complicity.

Two groups of gain can be set, and the gains can be switched through I/O input, communication, or internal variables, fulfilling flexible process demands.

## ■ Speed observer

Using a speed observer to reduce the noise signal impact and improve command following performance.

# User-friendly operation software

- Convenient and friendly user interface
- Enriched functions, easy to use
- Built-in instruction manual, practical for commissioning

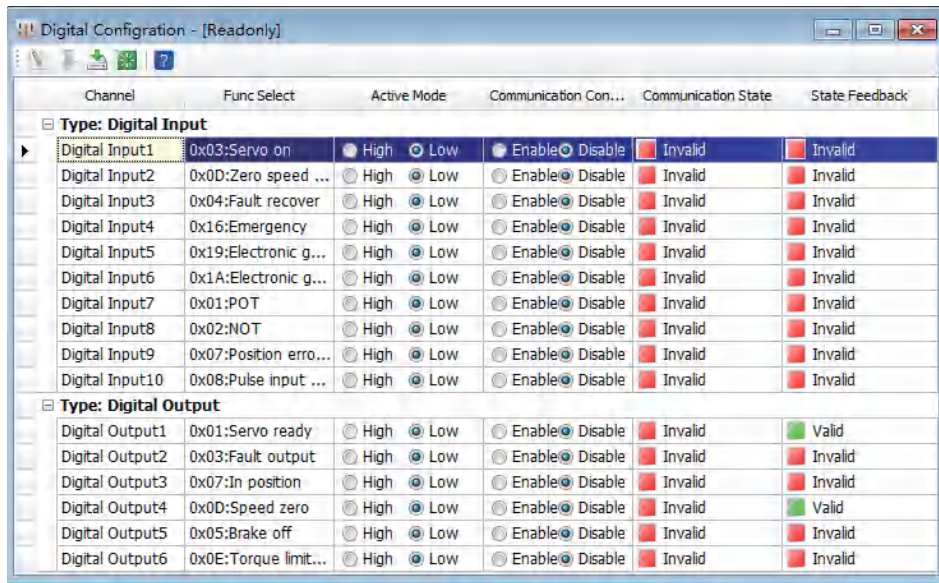

Digital I/O can directly select effective terminal logic and function distribution

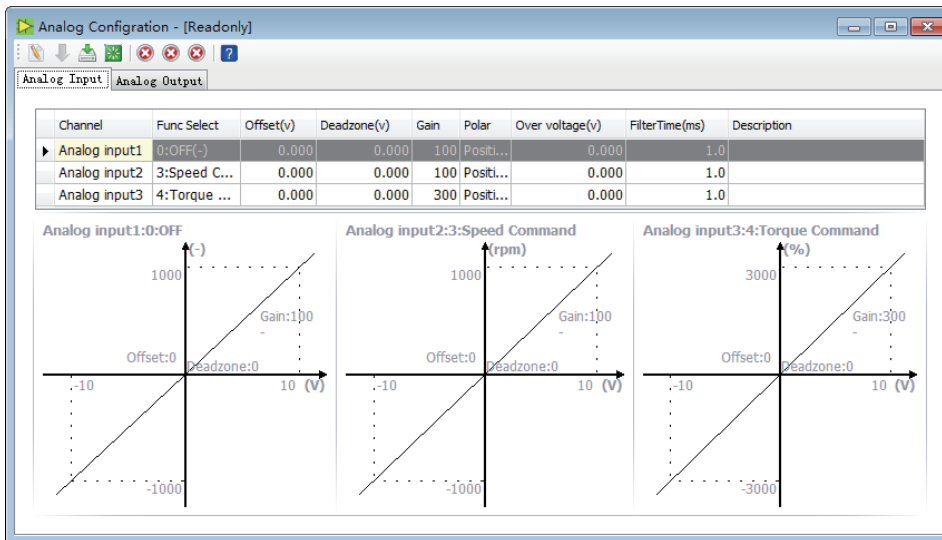

Analog I/O can set parameters such as gain, zero offset and deadzone, as shown above

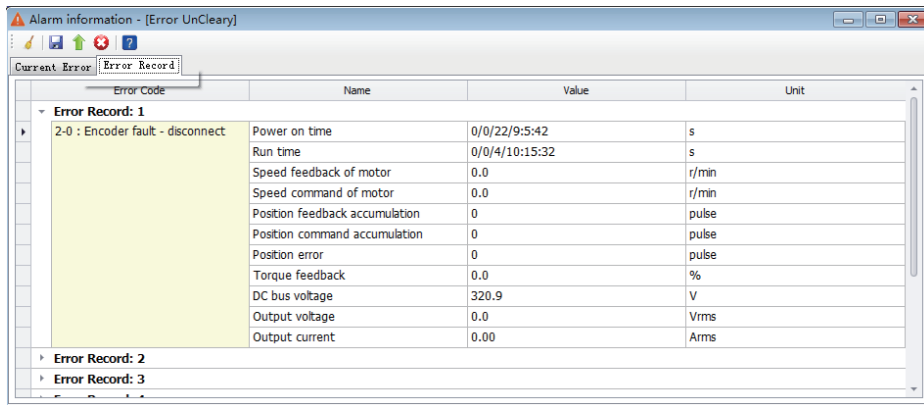

Display fault info. in real time and read fault record info

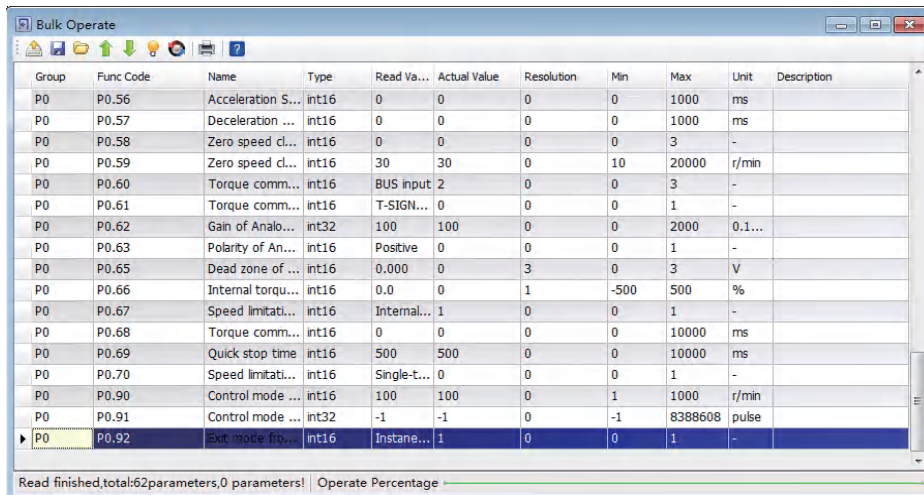

Bulk reading function can store parameters to files for easy parameter copying

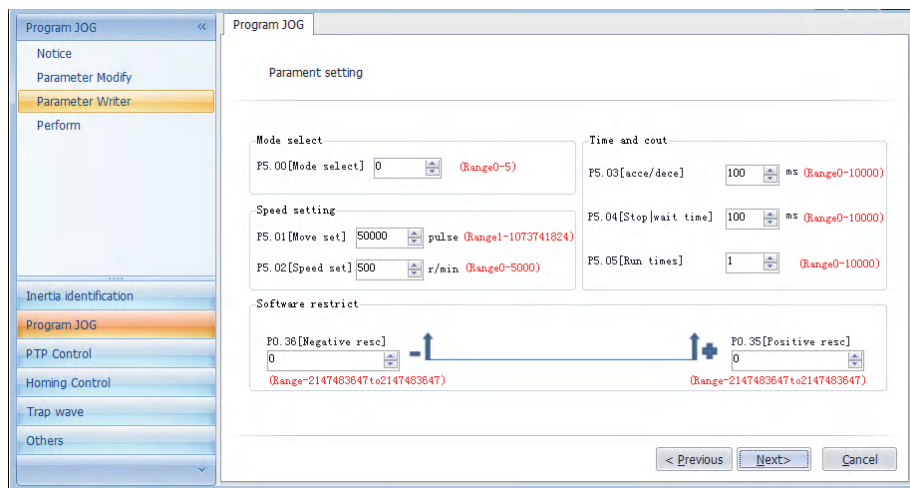

Abundant application control function for convenient pilot run and commissioning

# Application cases

## Mechanical arm/Robot

### Function description

- High speed and accuracy: DA200 EtherCAT bus servo uses the 23-bit absolute encoder, achieving the repeated positioning accuracy of  $\pm 0.01\text{mm}$  and the response frequency of 2.0kHz.
- High rigidity and flexibility: The high speed and accuracy control on continuous tracks in three dimensions ensures flexibility and accuracy of robot motions, applicable to processes such as high-efficiency dispensing, soldering, cutting, and coating, and compatible with any articulated robot controller.
- Automatic gain adjusting achieves optimum servo performance for each joint.



## LED die bonder

### Function description

- DA200 supports linear motors, no need for intermediate drive, featuring stronger torque output, quicker dynamic response, and greater ACC, making full use of advanced mechanical performance.
- Improving the die bonder production efficiency through the quick high-accuracy positioning and repeated positioning with the accuracy improved through linear position detection closed-loop feedback control.
- Achieving comprehensive vibration control and excellent disturbance control: fully-closed loop vibration control, low frequency vibration control, disturbance control friction torque compensation, and manual/automatic notch filter.
- Die bonding cycle reduced to 100ms.



## Lithium cell winding

### Function description

- DA200 EtherCAT bus, with high speed and real time features, supports a maximum of 64 axes, meeting control requirements on winding and soldering machines, and improving assembly efficiency.
- Integrated unwinding and rectification program and excellent algorithms, achieving quick winding, high accuracy cutting, with less tension fluctuation, stable constant linear speed control improving action response.
- Built-in electric cam, easily achieving variable/constant speed winding and quick type change through one key without setting any winding needle dimension parameter.
- Nearby installation for remote I/O, reducing wiring and maintenance costs.
- Winding curves achieved completely through autotuning, without the need to set any winding needle parameters.

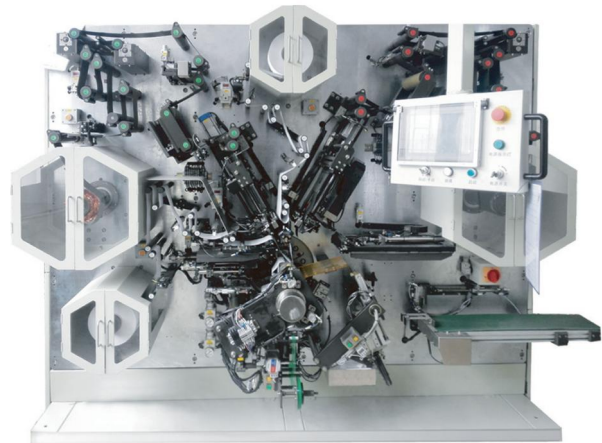

## LED sorting machine

### Function description

- Utilizing DA200 featuring high speed and excellent response can increase motor frequency width and improve the gains with quick dynamic response and short tuning time, optimizing overall running.
- Using the customized large torque motor with advanced algorithms can achieve high accuracy positioning control and low-speed stable running with high rigidity without microvibrations.
- The max. speed has reached 72K/h, highest level in the industry.
- Rotary table with large inertia, load rate slowed, motor temperature lowered, and noise reduced.
- Working efficiency improved by 80% and yield rate improved greatly.

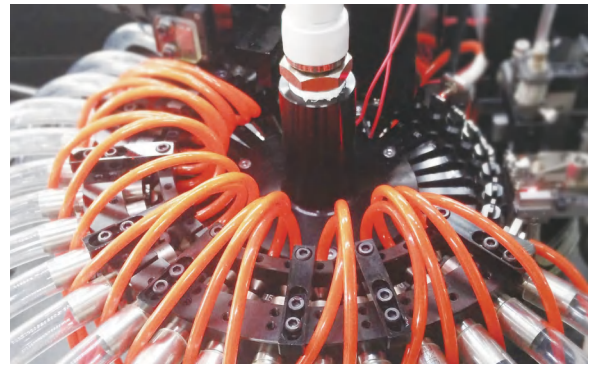



# Application cases

## Fully auto SMT machine

### Function description

- For excellent vibration control, DA200 can fully eliminate resonance and control vibration with quick response, ensuring the machine runs stably.
- Outstanding gantry dual-drive control algorithms ensure running accuracy.
- Excellent online position change function achieves real time change of target positions.
- The high speed and accuracy features help improve SMT production efficiency.



## Glass engraving and milling machine

### Function description

- Using DA200 to compensate for disturbance, friction, and reverse gap enables the machine to achieve cutting without marks and smooth lines and arcs.
- Excellent disturbance control compensates for load disturbance control and performance impact caused by parameter changes, improving system robustness and command following performance.
- Import of CADs for any graphs and auto optimization of glass cutting traces.
- 4MHz command pulse input.
- Intelligent gain adjusting and switching, implemented through one key.
- Built-in drive protection, featuring excellent environment adaptability and highly waterproof.





# Servo drive models

## SV-DA200-0R4-2-E 0-XXXX

①

Symbol	Product category
SV	Servo system product

①

②

Symbol	Product category
DA200	Servo drive

③

Symbol	Rated power
0R1	100W
0R2	200W
0R4	400W
0R7	750W
1R0	1.0kW
1R5	1.5kW
2R0	2.0kW
3R0	3.0kW
4R4	4.4kW
5R5	5.5kW
7R5	7.5kW
011	11kW
015	15kW
022	22kW
037	37kW
045	45kW
055	55kW

④

Symbol	Rated voltage
2	220VAC
4	400VAC

⑤

Symbol	Drive type
E	Pulse type
S	Standard type
C	CANopen bus type
N	EtherCAT bus type
F	PROFINET bus type
D	PROFIdrive bus type

⑥

Symbol	Encoder type
0	Photoelectric encoder <sup>(1)</sup>
7	Resolver

⑦

Symbol	Lot no.
XXXX	Manufacturer lot no. <sup>(2)</sup>
00Z0	Linear motor lot no.
00T0	Electronic cam lot no.

Remark:

(1).Photoelectric encoders include 2500-PPR incremental, 17-bit multiturm absolute, and 23-bit multiturm absolute encoders.

(2).Lot no. 00Z0 is for linear motors, and s should be 0 (namely, encoder type should be photoelectric encoder.)

### Function by drive type (small power range: 100W–5.5kW)

Drive type	Symbol	Pulse input	16-bit analog input	2 <sup>nd</sup> encoder	STO	RS485	CANopen	PROFINET	PROFIdrive	EtherCAT	Photoelectric encoder	Resolver
Pulse	E0	√	x	√	x	√	x	x	x	x	√	x
Standard	S0	√	√	√	√	√	x	x	x	x	√	x
	S7	√	√	√	√	√	x	x	x	x	x	√
Bus	C0	x	x	√	x	x	√	x	x	x	√	x
	F0	x	x	√	x	√	x	√	x	x	√	x
	N0	x	x	√	x	x	x	x	x	√	√	x
	D0	x	x	√	x	√	x	x	√	x	√	x

For N0,F0,D0 drive products, if you need STO function, you can communicate with the sales staff to buy customized models.

### Function by drive type (medium power range: 7.5W–55kW)

Drive type	Symbol	Pulse input	16-bit analog input	2 <sup>nd</sup> encoder	STO	RS485	CANopen	PROFINET	PROFIdrive	EtherCAT	Photoelectric encoder	Resolver
Standard	S0	√	√	√	√	√	√	x	x	x	√	x
	S7	√	√	√	√	√	√	x	x	x	x	√
Bus	N0	x	x	√	√	x	x	x	x	√	√	x
	N7	x	x	√	√	x	x	x	x	√	x	√
	F0	x	√	√	√	√	x	√	x	x	√	x
	F7	x	√	√	√	√	x	√	x	x	x	√
	D0	x	√	√	√	√	√	x	√	x	√	x
	D7	x	√	√	√	√	x	x	√	x	x	√

# Servo drive models

## Drive models and frame sizes

Model	Input		Output		Frame size
	Voltage (V)	Rated current (A)	Power (kW)	Rated current (A)	
SV-DA200-0R1-2	1PH/3PH 220	0.9/0.4	0.1	1.3	A
SV-DA200-0R2-2	1PH/3PH 220	1.8/0.8	0.2	1.8	A
SV-DA200-0R4-2	1PH/3PH 220	3.6/1.5	0.4	3.3	A
SV-DA200-0R7-2	1PH/3PH 220	6.8/2.8	0.75	4.5	B
SV-DA200-1R0-2	3PH 220	9.1/3.7	1.0	5	B
SV-DA200-1R5-2	3PH 220	5.6	1.5	7.6	B
SV-DA200-2R0-2	3PH 220	7.5	2.0	10	D
SV-DA200-3R0-2	3PH 400	11.2	3.0	13	D
SV-DA200-4R4-2	3PH 400	16.5	4.4	16.5	D
SV-DA200-1R0-4	3PH 400	2.1	1.0	3.5	B
SV-DA200-1R5-4	3PH 400	3.1	1.5	4.5	B
SV-DA200-2R0-4	3PH 400	4.1	2.0	6.5	C
SV-DA200-3R0-4	3PH 400	6.2	3.0	8.5	C
SV-DA200-4R4-4	3PH 400	9.1	4.4	12	D
SV-DA200-5R5-4	3PH 400	11.3	5.5	16	D
SV-DA200-7R5-4	3PH 400	15.5	7.5	25	F
SV-DA200-011-4	3PH 400	22.7	11	33	F
SV-DA200-015-4	3PH 400	31	15	50	F2
SV-DA200-022-4	3PH 400	45.4	22	66	G
SV-DA200-037-4	3PH 400	76	37	90	G
SV-DA200-045-4	3PH 400	93	45	112	H
SV-DA200-055-4	3PH 400	113	55	134	H

## Brake resistor specifications

Drive model	Built-in brake resistor spec.	Min. allowed resistance of external brake resistor
SV-DA200-0R1-2	/	60Ω
SV-DA200-0R2-2	/	60Ω
SV-DA200-0R4-2	/	60Ω
SV-DA200-0R7-2	30Ω60W	30Ω
SV-DA200-1R0-2	30Ω60W	30Ω
SV-DA200-1R5-2	30Ω60W	20Ω
SV-DA200-2R0-2	15Ω120W	15Ω
SV-DA200-3R0-2	15Ω120W	15Ω
SV-DA200-4R4-2	15Ω120W	15Ω
SV-DA200-1R0-4	60Ω60W	60Ω
SV-DA200-1R5-4	60Ω60W	60Ω
SV-DA200-2R0-4	60Ω60W	40Ω
SV-DA200-3R0-4	30Ω60W	30Ω
SV-DA200-4R4-4	30Ω120W	30Ω
SV-DA200-5R5-4	30Ω120W	30Ω
SV-DA200-7R5-4	/	30Ω
SV-DA200-011-4	/	20Ω
SV-DA200-015-4	/	15Ω
SV-DA200-022-4	/	10Ω
SV-DA200-037-4	/	10Ω
SV-DA200-045-4	/	5Ω
SV-DA200-055-4	/	5Ω

## EMI filter model selection

Drive model	EMI filter model
SV-DA200-0R1-2	FLT-P04006L-B
SV-DA200-0R2-2	
SV-DA200-0R4-2	
SV-DA200-0R7-2	
SV-DA200-1R0-4	
SV-DA200-1R5-4	
SV-DA200-1R0-2	FLT-P04016L-B
SV-DA200-1R5-2	
SV-DA200-2R0-4	
SV-DA200-3R0-4	
SV-DA200-2R0-2	
SV-DA200-3R0-2	
SV-DA200-4R4-4	FLT-P04032L-B
SV-DA200-4R4-2	
SV-DA200-5R5-4	
SV-DA200-7R5-4	
SV-DA200-011-4	FLT-P04045L-B
SV-DA200-015-4	FLT-P04065L-B
SV-DA200-022-4	FLT-P04100L-B
SV-DA200-037-4	FLT-P04100L-B
SV-DA200-045-4	FLT-P04150L-B
SV-DA200-055-4	FLT-P04150L-B

Remarks: The EMI filter models in the table are INVT EMI filter models, used at the power input end.

## Drive dimensions

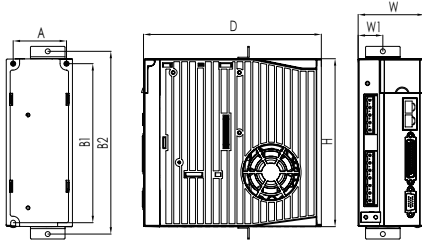

Dimensional drawing for frame sizes A, B, and C

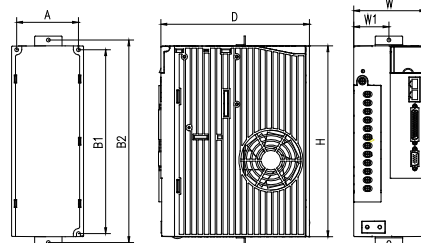

Dimensional drawing for frame size D

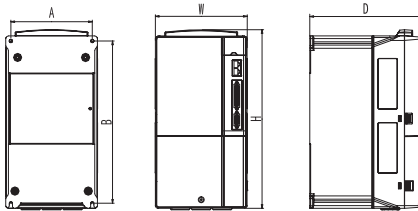

Dimensional drawing for frame sizes F and F2

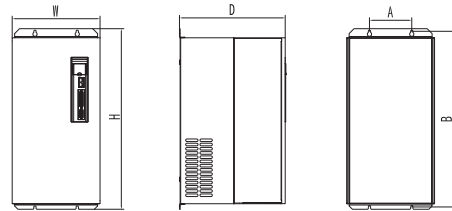

Dimensional drawing for frame size G

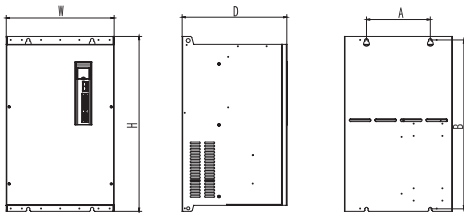

Dimensional drawing for frame size H











Frame size	Model	Outline dimensions			Installation dimensions				Installation size hole (mm)
		H(mm)	W(mm)	D(mm)	A(mm)	B1(mm)	B2(mm)	W1(mm)	
A	SV-DA200-0R1-2	170	45	170	33	162	185	22.5	M4(Φ5)
	SV-DA200-0R2-2								
	SV-DA200-0R4-2								
B	SV-DA200-0R7-2	170	67	180	54	162	185	25	M4(Φ5)
	SV-DA200-1R0-2								
D	SV-DA200-1R5-2	245	92	190	79	237	260	45	M4(Φ5)
	SV-DA200-2R0-2								
	SV-DA200-3R0-2								
B	SV-DA200-4R4-2	170	67	180	54	162	185	25	M4(Φ5)
	SV-DA200-1R0-4								
C	SV-DA200-1R5-4	170	84	180	71	162	185	42	M4(Φ5)
	SV-DA200-2R0-4								
D	SV-DA200-3R0-4	245	92	190	79	237	260	45	M4(Φ5)
	SV-DA200-4R4-4								
F	SV-DA200-5R5-4	342	230	208	210	311	/	/	M5(Φ6)
	SV-DA200-7R5-4								
F2	SV-DA200-011-4	407	255	238	237	384	/	/	M6(Φ7)
G	SV-DA200-015-4	555	270	325	130	540	/	/	M6(Φ7)
	SV-DA200-022-4								
H	SV-DA200-037-4	554	338	328	200	535	/	/	M8(Φ10)
	SV-DA200-045-4								
	SV-DA200-055-4								

# Servo drive technical parameters

DA200 series servo drive (100W–55kW)				
Specification		Description		
Power	220V system input voltage	1P/3P AC 220V(-15%)~240V(+10%) 47Hz~63 Hz		
	400V system input voltage	3P AC 380V(-15%)~440V(+10%) 47Hz~63Hz		
Port	Control signal	Input	10 inputs for standard type, pulse type and CANopen bus type; 7 inputs for EtherCAT bus type; 7 inputs for PROFINET bus type(functions can be configured via relevant parameters)	
		Output	6 outputs for standard type, pulse type and CANopen bus type; 4 outputs for EtherCAT bus type; 4 outputs for PROFINET bus type(functions can be configured via relevant parameters)	
	Analog	Input	3 inputs for standard type (one 16bit, two 12bit analog inputs) 2 inputs for non-standard type (two 12bit analog inputs)	
		Output	2 outputs ( analog monitoring output)	
	Pulse signal	Input	1 input (mode: differential input or open collector)	
		Output	1 output (mode: differential output (A+, A-, B+, B-, Z+, Z-) or open collector output (A; B; Z))	
	2 <sup>nd</sup> encoder	Input	Incremental encoder interface (2nd encoder or grating ruler)	
	Communication	USB	1:1 communication upper PC software (standard)	
		RS485	1:n communication (standard)	
		CANopen	1:n communication (optional)	
		PROFINET	1:n communication (optional)	
		PROFIdrive	1:n communication (optional)	
	Safety terminal	EtherCAT	1:n communication (optional)	
		STO	Safe Torque Off (comply with latest Euro safety standard) (optional)	
	Control mode		1. Position control; 2. Speed control; 3. Torque control; 4. Position/speed mode switching; 5. Speed/torque mode switching; 6. Position/torque mode switching; 7. Fully-closed loop control; 8. CANopen mode; 9. EtherCAT mode	
Function	Position control	Control input	1. Residual pulse clearing; 2. Command pulse input disabled; 3. Electronic gear ratio switching; 4. Vibration control switching	
		Control output	Position complete output	
		Pulse input	Max. pulse input frequency	Photoelectric coupling: differential input 4Mpps, open collector input 200kpps
			Pulse input mode	1. Pulse+direction; 2. CW+CCW; 3. Quadrature encoding
			Electronic gear	1/10000~1000
		Filter	1. Command smooth filter; 2. FIR filter	
		Analog input	Torque limit	Can perform clockwise/anticlockwise torque limit separately
		Vibration control	Can control 5–200Hz front-end vibration and machine vibration	
Pulse output	1. Can perform any frequency division setting which is below encoder resolution rate; 2. B phase reversing function			

DA200 series servo drive (100W-55kW)					
Specification		Description			
Function	Speed control	Control input	1. Internal command speed selection 1; 2. Internal command speed selection 2; 3. Internal command speed selection 3; 4. Zero speed clamp		
		Control output	Speed reaching, etc. Speed reaching, etc.		
		Analog input	Speed command input	Can set to speed command input based on analog voltage DC±10V	
			Speed limit input	Can carry out torque limit clockwise/anticlockwise separately	
		Internal speed command	Can switch between internal 8-step speed based on external input control		
		Speed command acc/dec adjustment	Can set acc/dec time separately or set acc/dec of S curve		
		Zero speed clamp	In speed mode, zero speed clamp function can set to work in speed mode or position mode		
		Speed command filter	First-order delay filter of analog input speed command		
	Speed command zero drift control	Can carry out zero drift control against peripheral disturbance, precision 0.3mV			
	Torque control	Control input	Zero speed clamp input, etc.		
		Control output	Speed reaching, etc.		
		Analog input	Torque command input	Analog torque command input, can set gain and polarity based on analog voltage, precision 4.88mV	
			Speed limit input	Can carry out analog speed limit	
		Speed limit	Speed limit can be set via parameters		
		Torque command filter	First-order delay filter of analog input torque command		
	Torque command zero drift control	Can carry out zero drift control against peripheral disturbance, precision is 4.88mV			
	Internal position planning	Plan points	Can carry out 128-point internal position plan setting, support communication control positioning		
		Route setting	1. Position; 2. Speed; 3. Acc time; 4. Dec time; 5. Stop timer; 6. Various state output; 7. Running mode		
Homing		1. LS signal; 2. Z phase signal; 3. LS signal+Z phase signal; 4. Torque limit signal			
Protection	Hardware protection		Overvoltage, undervoltage, overcurrent, overspeed, overload, overheat, brake resistor overload, encoder fault, etc.		
	Software protection		Storage fault, initialization fault, I/O distribution error, position deviation is too large, etc.		
	Protection and fault record		1. Can record up to 10 faults 2. Can record the key parameter value when fault occurred		
Environment	Temperature	Working temp	0~45°C		
		Storage temp	-20~80°C(Non frozen)		
	Working/storage RH		90%RH(no condensation)		
	IP level		IP20		
	Elevation		Below 1000m		
	Vibration		≤5.88m/s <sup>2</sup> , 10-60Hz (Do not work on resonance point)		

# Servo drive configuration table

1PH/3PH 220V										
Servo drive										
	SIZE A			SIZE B			SIZE D			
	SV-DA200-0R1-2	SV-DA200-0R2-2	SV-DA200-0R4-2	SV-DA200-0R7-2	SV-DA200-1R0-2	SV-DA200-1R5-2	SV-DA200-2R0-2	SV-DA200-3R0-2	SV-DA200-4R4-2	
Servo motor	IMS20A-04L10B30C-2-***	IMS20A-06M20B30C-2-***	IMS20A-06M40B30C-2-***	IMS20A-08M75B30C-2-***	IMS20A-08M10C25C-2-***	IMS20A-10M10C30C-2-***	IMS20A-10M15C30C-2-***	IMS20A-13H18C15C-2-***-A1		
	-			-	IMS20A-13M10C20C-2-***-A1	IMS20A-13M15C20C-2-***-A1	IMS20A-13M20C20C-2-***-A1	IMS20A-13H13C15C-2-***-A	IMS20A-13M30C20C-4-***-A1	-
	-			-		IMS20A-13H85B15C-2-***-A	IMS20A-13H13C15C-2-***-A	IMS20A-13M30C20C-4-***-A1	-	
3PH 400V										
Servo drive										
	SIZE B			SIZE C			SIZE D			
	SV-DA200-1R0-4	SV-DA200-1R5-4	SV-DA200-2R0-4	SV-DA200-3R0-4	SV-DA200-4R4-4	SV-DA200-5R5-4				
Servo motor	IMS20A-08M10C25C-4-***	IMS20A-10M15C30C-4-***	IMS20A-10M20C30C-4-***	IMS20A-13M30C20C-4-***	IMS20A-18M44C15C-4-***	IMS20A-18M55C15C-4-***				
	IMS20A-13M10C20C-4-***-A1	IMS20A-13M15C20C-4-***-A1	IMS20A-13H18C15C-4-***-A	IMS20A-18M30C15C-4-***						
	IMS20A-10M10C30C-4-***	IMS20A-13H85B15C-4-***-A	IMS20A-13M20C20C-4-***-A1	-						
Servo drive										
	SIZE F			SIZE F2			SIZE G			
	SV-DA200-7R5-4	SV-DA200-011-4	SV-DA200-015-4	SV-DA200-022-4	SV-DA200-037-4					
Servo motor	IMS20A-18M75C15C-4-***	IMS20A-20M11D18C-4-***	IMS20A-20M18D18C-4-***	IMS20A-20M25D18C-4-***	IMS20A-26M41D20C-4-***					
	IMS20A-20M16D20C-4-***		-		-					
	-		-		-					
Servo drive										
	SIZE H									
	SV-DA200-045-4	SV-DA200-055-4								
Servo motor	IMS20A-26M48D20C-4-***	IMS20A-26M56D20C-4-***								
	IMS20A-26M64D20C-4-***									



# Servo motor models

## Naming rules

IMS20A-06 M 20B 30C-2-P9□□

①
②
③
④
⑤
⑥
⑦
⑧
⑨

Symbol	Symbol instruction	Product category
①	series	IMS Motor
②	Flange (mm)	04:40 06:60 08:80 10:100 11:110 13:130 18:180 20:200 26:263
③	Inertia	L: Light inertia M:Medium inertia H:Heavy inertia
④	Rated power (W)	A: X1 B: X10 C: X100 D: X1000 E: X10000 Eg: 40B means 40*10=400W, 55C means 55*100=5500W
⑤	Rated speed (rpm)	A: X1 B: X10 C: X100 D: X1000 E: X10000 Eg: 30C means 30*100=3000rpm
⑥	Rated voltage (V)	2:220 4:380
⑦	Encoder type	N: without P: optical M: magnetic R: resolver 3:17bits single-turn 4:17bits multi-turn 9: 23bits multi-turn
⑧	Seal&brake	0: with oil seal and no brake(standard omission) 1: without oil seal and no brake 2: with oil seal and permanent magnet brake 3: without oil seal and permanent magnet brake 4: with oil seal and electromagnet brake 5: without oil seal and electromagnet brake
⑨	Cooling	N: Nature cooling(Default omission) F: Fan cooling

# Servo motor technical parameters

## Motor specification (2500-PPR/multi-turn absolute/resolver)

Flange (mm)	Motor model	Rated power (kW)	Rated torque (Nm)	Max torque Nm	Rated speed (rpm)	Max. speed (rpm)	Voltage (V)	Rated current(A) 220V/(380V)	Initial 10-4kg·m2 without brake/with brake	Shaft extension/ Shaft diameter mm	Bond width mm
40	IMS20A-04L10B30C-2-***	0.1	0.3	1.1	3000	6000	220	1.8	0.066/0.067	25/8	3
60	IMS20A-06M20B30C-2-***	0.2	0.64	1.92	3000	6000	220	1.8	0.32/0.37	30/14	5
60	IMS20A-06M40B30C-2-***	0.4	1.27	3.82	3000	6000	220	3	0.68/0.73	30/14	5
80	IMS20A-08M75B30C-2-***	0.75	2.4	7.2	3000	5500	220	4.8	1.72/1.77	35/19	6
80	IMS20A-08M10C25C-2-***	1	3.6	11.4	2500	3000	220	4.8	2.15/2.4	35/19	6
100	IMS20A-10M10C30C-2(4)-***	2	3.2	9.6	3000	5000	220(380)	7/3.9	2.43	45/24	8
100	IMS20A-10M15C30C-2(4)-***	1.5	4.9	14.7	3000	5000	220(380)	8.5/5.1	3.503	45/24	8
100	IMS20A-10M20C30C-4-***	2	5.4	19.2	3000	5000	380	6.6	4.49	45/24	8
130	IMS20A-13M10C20C-2(4)-***-A1	1	4.78	14.4	2000	3000	220(380)	5.5/3	6.3/7.95	57/22	8
130	IMS20A-13M15C20C-2(4)-***-A1	1.5	7.16	21.4	2000	3000	220(380)	7.6/4.5	9.23/11.13	57/22	8
130	IMS20A-13M20C20C-2(4)-***-A1	2	9.55	28.6	2000	3000	220(380)	9.5/5	12.15/14.05	57/22	8
130	IMS20A-13M30C20C-4-***-A1	3	14.3	42	2000	3000	380	13.6/8	18/19.9	57/22	8
130	IMS20A-13H85B15C-2(4)-***-A	0.85	5.4	14.2	1500	3000	220(380)	6/3.5	13.4/14.1	57/22	8
130	IMS20A-13H13C15C-2(4)-***-A	1.3	8.4	22.8	1500	3000	220(380)	10/5	17.9/19.1	57/22	8
130	IMS20A-13H18C15C-2(4)-***-A	1.8	11.5	28.6	1500	3000	220(380)	14/8	24.3/25.6	57/22	8
180	IMS20A-18M30C15C-4-***	3	19	48	1500	3300	380	10	65.4/69.7	79/35	10
180	IMS20A-18M44C15C-4-***	4.4	28	70	1500	3300	380	14.3	85.9/90.2	79/35	10
180	IMS20A-18M55C15C-4-***	5.5	35	87.5	1500	3300	380	19	106.2/110.5	113/42	12
180	IMS20A-18M75C15C-4-***	7.5	48	130	1500	3000	380	22.5	133/137.3	113/42	12

1. Voltage difference in Model: -2 means 220V,-4 means 400V

2.-\*\*\* can be defined as encoder type&brake type:-M3 means 17bits magnetic encoder ,-M34 means 17bits magnetic encoder&electromagnetic brake;-P9 means 23bits optical multi-turn encoder,-P94 means 23bits optical multi-turn encoder&electromagnetic brake

200	IMS20A-20M11D18C-4-***F	11	59	147	1800	2500	380	29	86.3	82/42	12
200	IMS20A-20M16D20C-4-***F	16	77	192	2000	2500	380	34	98.5	82/42	12
200	IMS20A-20M18D18C-4-***F	18	95	237	1800	2500	380	34.6	144	82/42	12
200	IMS20A-20M25D18C-4-***F	25	133	330	1800	2500	380	52	182	82/42	12
263	IMS20A-26M41D20C-4-***F	41	195	485	2000	2500	380	84.8	370	110/48	14
263	IMS20A-26M48D20C-4-***F	48	230	575	2000	2500	380	104	426	110/48	14
263	IMS20A-26M56D20C-4-***F	56	265	660	2000	2500	380	115	523	110/48	14
263	IMS20A-26M64D20C-4-***F	64	306	765	2000	2500	380	130	606	110/48	14

1.-\*\*\* can be defined as encoder type,cooling type&brake type:-R7 means resolver;-P94F means 23bits optical multi-turn encoder,electromagnetic brake&Fan cooling

# Servo motor installation dimensions

## Base-40 motor outline dimensions (unit: mm)

Motor model 2500-PPR/Multiturn absolute/ Resolver	L(mm)	
	Without brake	With EM brake
IMS20A-04L10B30C-2-***	84.8	124

Note: Motor structure dimensions may vary with design modification. If you are sensitive to motor dimensions, contact sales staff before ordering.

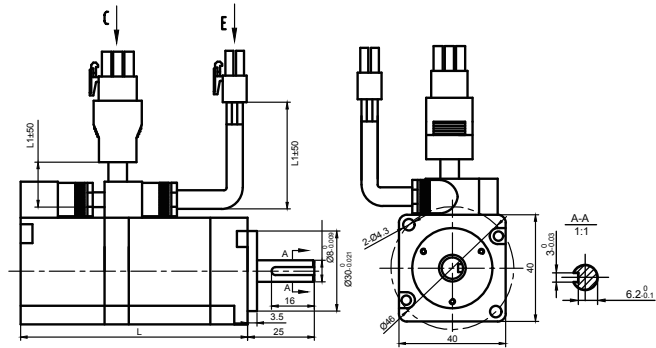

## Base-60 motor outline dimensions (unit: mm)

Motor model 2500-PPR/Multiturn absolute/ Resolver	L(mm)	
	Without brake	With EM brake
IMS20A-06M20B30C-2-***	87	110.5
IMS20A-06M40B30C-2-***	107	130.5

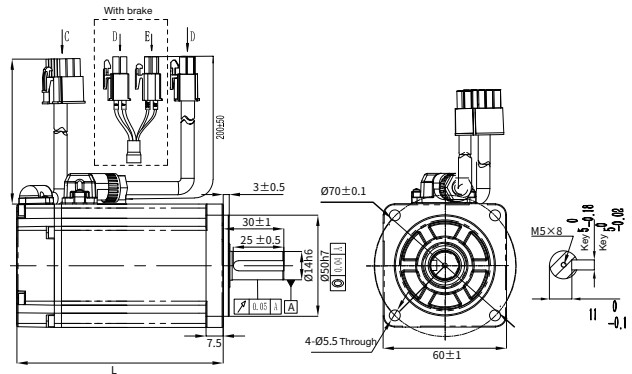

## Base-80 motor outline dimensions (unit: mm)

Motor model 2500-PPR/Multiturn absolute/ Resolver	L(mm)	
	Without brake	With EM brake
IMS20A-08M75B30C-2-***	119	143.5
IMS20A-08M10C25C-2-***	153	154

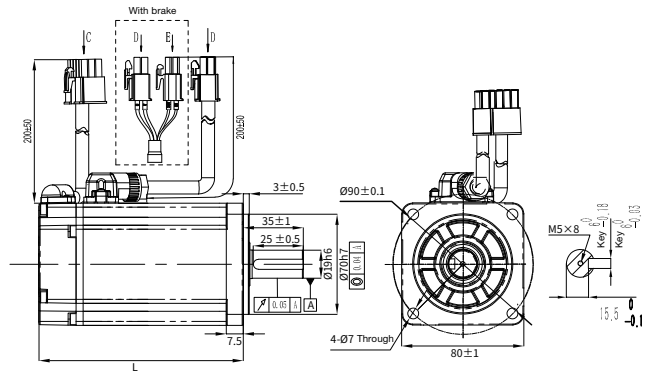

# Servo motor installation dimensions

Note: Motor structure dimensions may vary with design modification. If you are sensitive to motor dimensions, contact sales staff before ordering.

## Base-100 motor outline dimensions (unit: mm)

Motor model Magnetic,optical absolute/Resolver	L(mm)	
	Without brake	With EM brake
IMS20A-10M10C30C-2(4)-**	154	194
IMS20A-10M15C30C-2(4)-***	178	218
IMS20A-10M20C30C-4-***	200	240

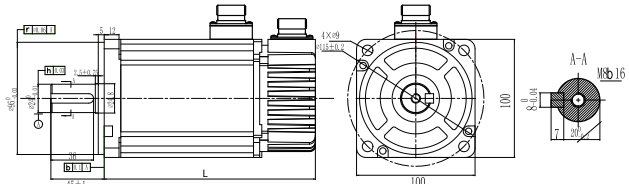

## Base-130 motor outline dimensions (unit: mm)

Motor model Magnetic,optical absolute/Resolver	L(mm)	
	Without brake	With EM brake
IMS20A-13M10C20C-2(4)-***-A1	138.5	168.2
IMS20A-13M15C20C-2(4)-***-A1	151.5	181.2
IMS20A-13M20C20C-2(4)-***-A1	168.5	198.2
IMS20A-13M30C20C-2(4)-***-A1	210.5	240.2
IMS20A-13H85B15C-2(4)-***-A	143	173
IMS20A-13H13C15C-2(4)-***-A	160	190
IMS20A-13H18C15C-2(4)-***-A	185	215

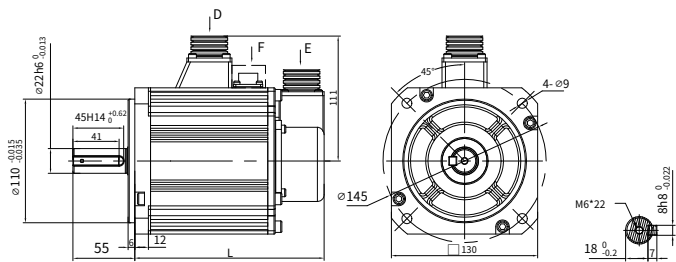

## Base-180 motor outline dimensions (unit: mm)

Motor model Magnetic,optical absolute/Resolver	L(mm)	
	Without brake	With EM brake
180 flange motor A type axes IMS20A-18M30C15C-4-***	233	306
IMS20A-18M44C15C-4-***	263	336
180 flange motor B type axes IMS20A-18M55C15C-4-***	293	366
IMS20A-18M75C15C-4-***	348	421

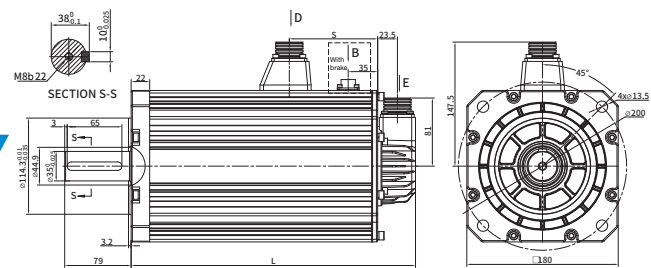

180 flange motor A type axes

IMS20A-18M30C15C-4-\*\*\*  
IMS20A-18M44C15C-4-\*\*\*

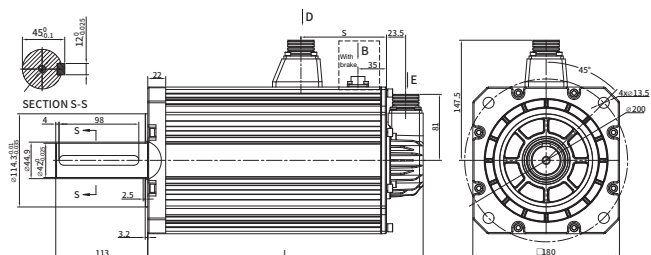

180 flange motor B type axes

IMS20A-18M55C15C-4-\*\*\*  
IMS20A-18M75C15C-4-\*\*\*

### Base-200 motor outline dimensions (unit: mm)

Motor model Magnetic,optical absolute/Resolver	L(mm)	
	Without brake	With EM brake
IMS20A-20M11D18C-4-***	379	515
IMS20A-20M16D20C-4-***	414	550
IMS20A-20M18D18C-4-***	484	638
IMS20A-20M25D18C-4-***	554	692

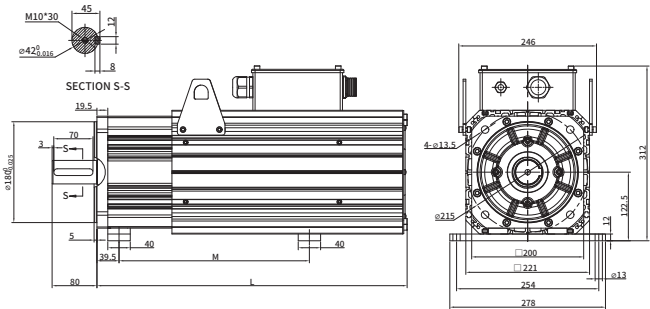

The length of M could be adjusted within the range of L.

### Base-263 motor outline dimensions (unit: mm)

Motor model 2500-PPR/Multiturn absolute/ Resolver	L(mm)	
	Without brake	
IMS20A-26M41D20C-4-***	537	
IMS20A-26M48D20C-4-***	537	
IMS20A-26M56D20C-4-***	617	
IMS20A-26M64D20C-4-***	657	

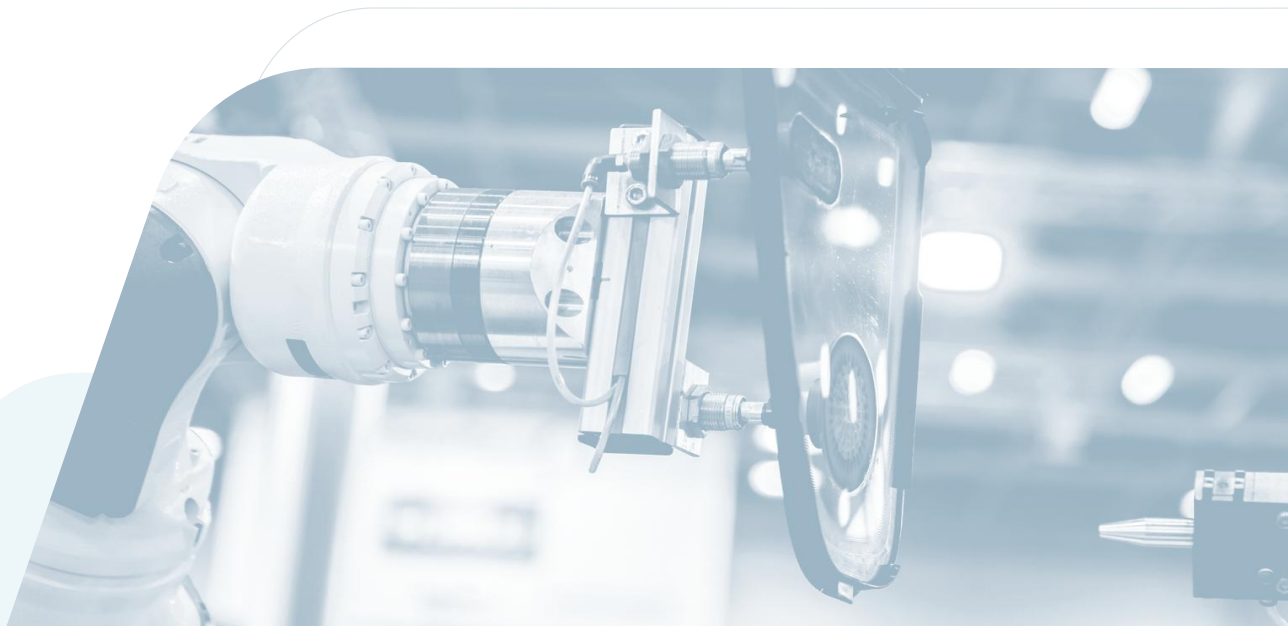
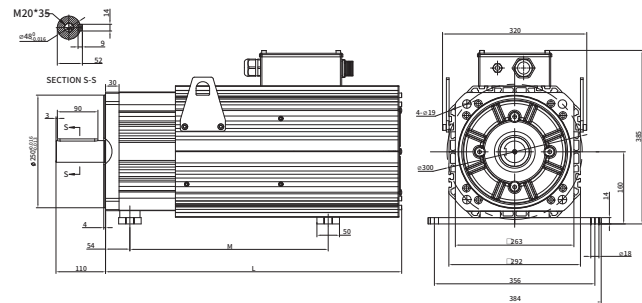

# Servo motor torque-speed characteristic

Note: A is a continuous working area; B is a short-time working area.

## Base-40 motor

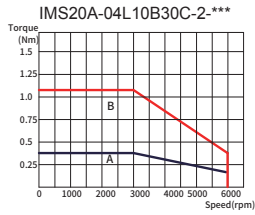

## Base-60 motor

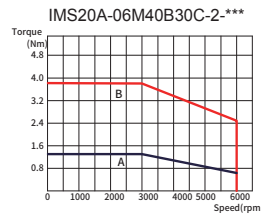
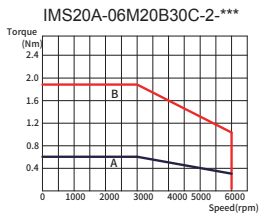

## Base-80 motor

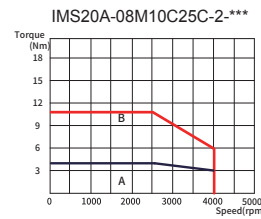
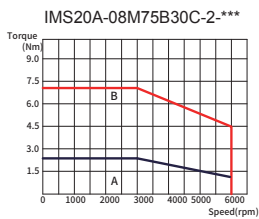

## Base-100 motor

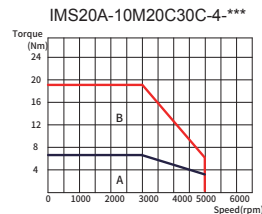
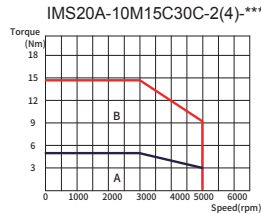
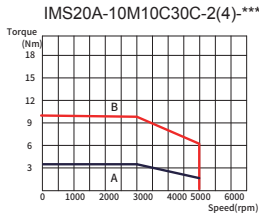



Base-130 motor

IMS20A-13M10C20C-2(4)-\*\*\*-A1

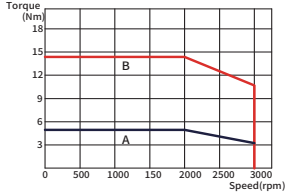

IMS20A-13M15C20C-2(4)-\*\*\*-A1

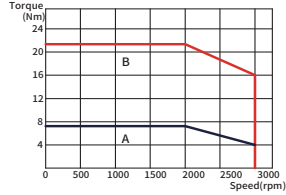

IMS20A-13M20C20C-2(4)-\*\*\*-A1

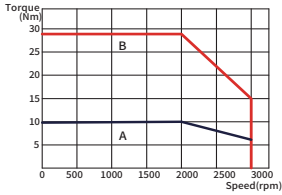

IMS20A-13M30C20C-4-\*\*\*-A1

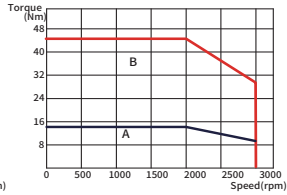

IMS20A-13H85B15C-2(4)-\*\*\*-A

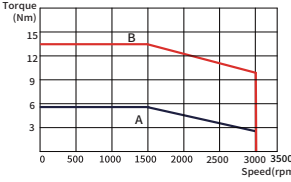

IMS20A-13H13C15C-2(4)-\*\*\*-A

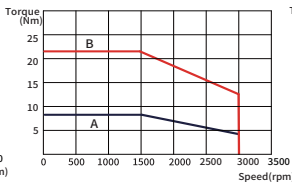

IMS20A-13H18C15C-2(4)-\*\*\*-A

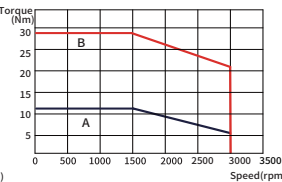

Base-180 motor

IMS20A-18M30C15C-4-\*\*\*

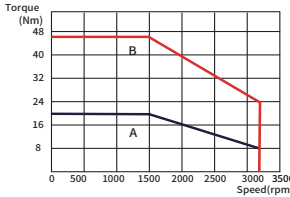

IMS20A-18M44C15C-4-\*\*\*

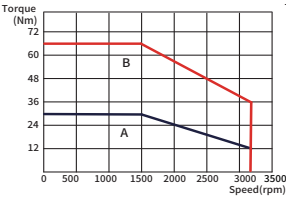

IMS20A-18M55C15C-4-\*\*\*

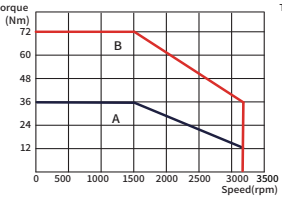

IMS20A-18M75C15C-4-\*\*\*

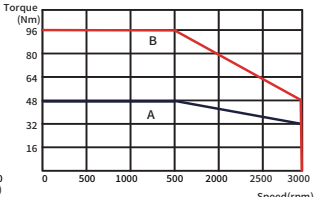

Base-200/263 motor

IMS20A-20M11D18C-4-\*\*\*

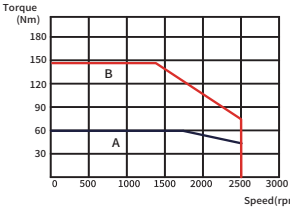

IMS20A-20M16D20C-4-\*\*\*

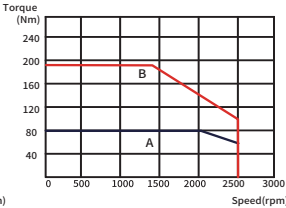

IMS20A-20M25D18C-4-\*\*\*

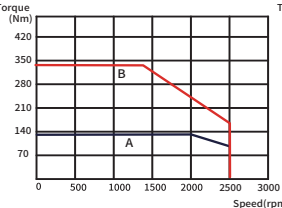

IMS20A-26M41D20C-4-\*\*\*

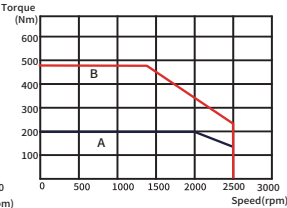

IMS20A-26M48D20C-4-\*\*\*

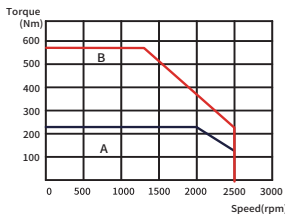

IMS20A-26M56D20C-4-\*\*\*

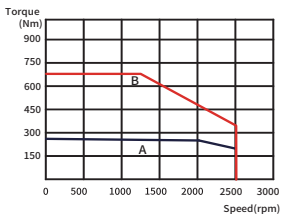

IMS20A-26M64D20C-4-\*\*\*

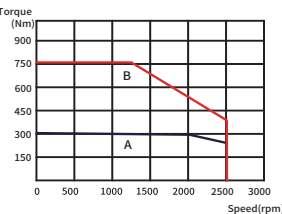

# Servo motor power cable models

## Power cable

DA ML-050-03-A F 0-00

①      ②      ③      ④      ⑤      ⑥      ⑦      ⑧

## Power cable accessories

DA ML - A F

①      ②      ⑤      ⑥

①

Symbol	Supporting series
DA	Manufacturer no.

②

Symbol	Cable type
ML	Power cable

③

Symbol	Cable diameter
050	0.5 mm <sup>2</sup>
100	1.0 mm <sup>2</sup>
250	2.5 mm <sup>2</sup>
600	6.0 mm <sup>2</sup>
10R	10 mm <sup>2</sup>
16R	16 mm <sup>2</sup>
25R	25 mm <sup>2</sup>

④

Symbol	Cable length
03	3m
05	5m
10	10m
...	Other

⑤

Symbol	Motor end plug
A	4PIN plastic plug
B	4PIN regular aviation plug YD28
N	Regular aviation plug YD32
S	Copper tube terminal SC

⑥

Symbol	Drive end plug
F	Tube-type terminal
W	Fork-type terminal
S	Copper tube terminal SC

⑦

Symbol	Cable material
0	Regular cable
A	Shielded regular cable
B	Shielded flexible towline cable
F	Flexible towline cable

⑧

Symbol	Lot no.
00	Standard product
...	Other

## Brake cable

BRKL - 03 - A

①      ②      ③

①

Symbol	Product series
BRKL	Motor brake cable

②

Symbol	Cable length
03	3m
...	Other

③

Symbol	Motor end plug
A	2PIN metal plug
B	3PIN regular aviation plug
C	3PIN metal plug
D	2PIN plastic plug

Remark: Brake plug in motor package

# Servo motor power cable wiring

## Power cable for base 40/60/80, 100W–1kW motor

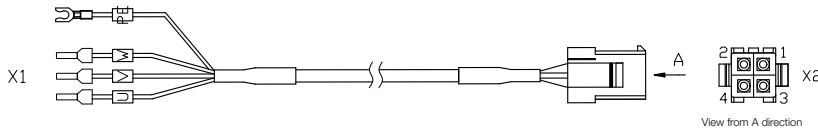

Wiring relation			
Signal	X1	X2	Color of core cable
W	Tube-type terminal	X2.3	Red
V	Tube-type terminal	X2.1	green
U	Tube-type terminal	X2.2	Yellow
PE	Fork-type terminal	X2.4	Yellow/green

## Power cable for base 100/130/180, 1~2kW(220V)/0.85~7.5kW(380V) motor

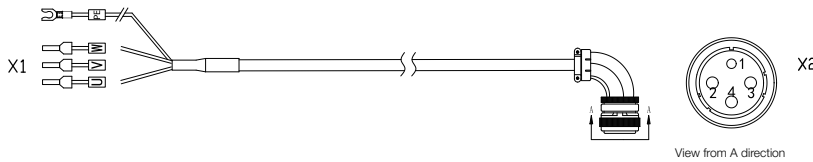

Wiring relation			
Signal	X1	X2	Color of core cable
W	Tube-type terminal	X2.4	Red
V	Tube-type terminal	X2.3	green
U	Tube-type terminal	X2.2	Yellow
PE	Fork-type terminal	X2.1	Yellow/green

Remark: (X2 side)100,130 flange motor use plug type YD28,180 flange motor use plug type YD32.

## Power cable for base 200/263, 11kW–55kW (380V) motor

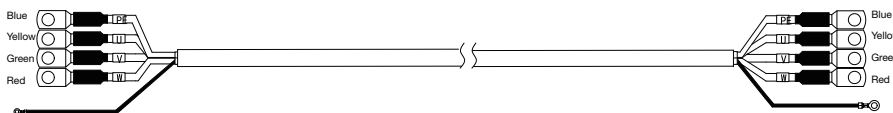

# Servo motor encoder cable models

## Encoder cable

DB EL - 04 - 03 - B 0 - 04 00  
 ①      ②                      ③      ④                      ⑤ ⑥                      ⑦      ⑧

## Encoder cable accessories

DB EL-A B  
 ①      ②      ⑨      ⑤

①

Symbol	Symbol
DB	Manufacturer no.

②

Symbol	Cable type
EL	Encoder cable

③

Symbol	Number of cable cores
04	4
06	6

④

Symbol	Cable length
03	3m
05	5m
10	10m
...	Other

⑤

Symbol	Motor end plug
B	15PIN regular aviation plug YD28
D	9PIN plastic plug

⑥

Symbol	Cable material
0	Regular cable
D	Regular cable with battery holder
F	Flexible towline cable
H	Flexible towline cable with battery holder

⑦

Symbol	Encoder type
04	Absolute
07	Resolver

⑧

Symbol	Lot no.
00	Standard part
...	Other

⑨

Symbol	Drive end plug
A	15PIN DB plug

# Servo motor encoder cable wiring

## Cable for magnetic & optical abs encoder used by flange 40/60/80 motor

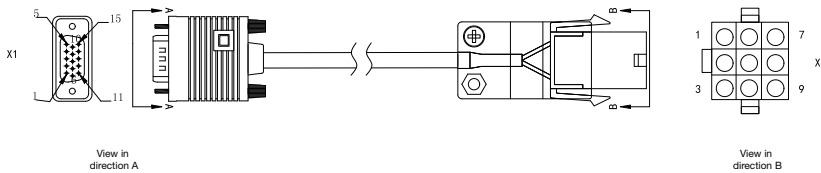

Wiring relation			
Signal	X1	X2	Core cable structure
SD+	X1.1	X2.1	Twisted pair
SD-	X1.7	X2.2	Twisted pair
5V	X1.5	X2.6	Twisted pair
GND	X1.12	X2.7	Twisted pair
VB+	/	X2.3	Twisted pair
VB-	/	X2.8	Twisted pair
PE	Metal shell	X2.9	Woven

## Cable for magnetic & optical abs encoder used by flange 100/130/180/200/263 motor

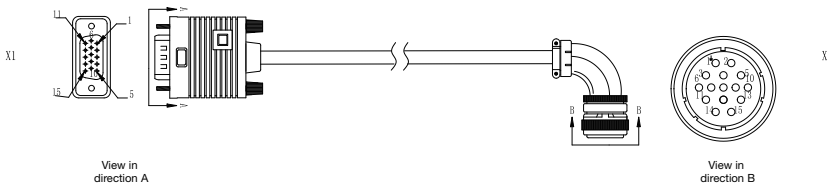

Wiring relation			
Signal	X1	X2	Core cable structure
SD+	X1.1	X2.2	Twisted pair
SD-	X1.7	X2.3	Twisted pair
5V	X1.5	X2.4	Twisted pair
GND	X1.12	X2.5	Twisted pair
VB+	/	X2.6	Twisted pair
VB-	/	X2.7	Twisted pair
PE	Metal shell	X2.1	Woven

## Cable for resolver encoder used by flange 200/263 motor

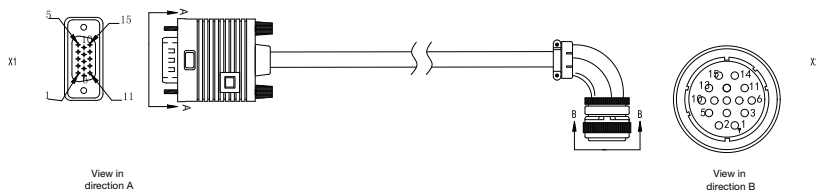

Wiring relation			
Signal	X1	X2	Core cable structure
SIN+	X1.1	X2.6	Twisted pair
SIN-	X1.7	X2.7	Twisted pair
COS+	X1.2	X2.5	Twisted pair
COS-	X1.8	X2.4	Twisted pair
R+	X1.5	X2.2	Twisted pair
R-	X1.12	X2.3	Twisted pair
PE	Metal shell	X2.1	Woven

# Connection ports

Note: Standard-type examples

Medium power range: 100W–5.5kW

## Wiring diagram of main circuit terminal

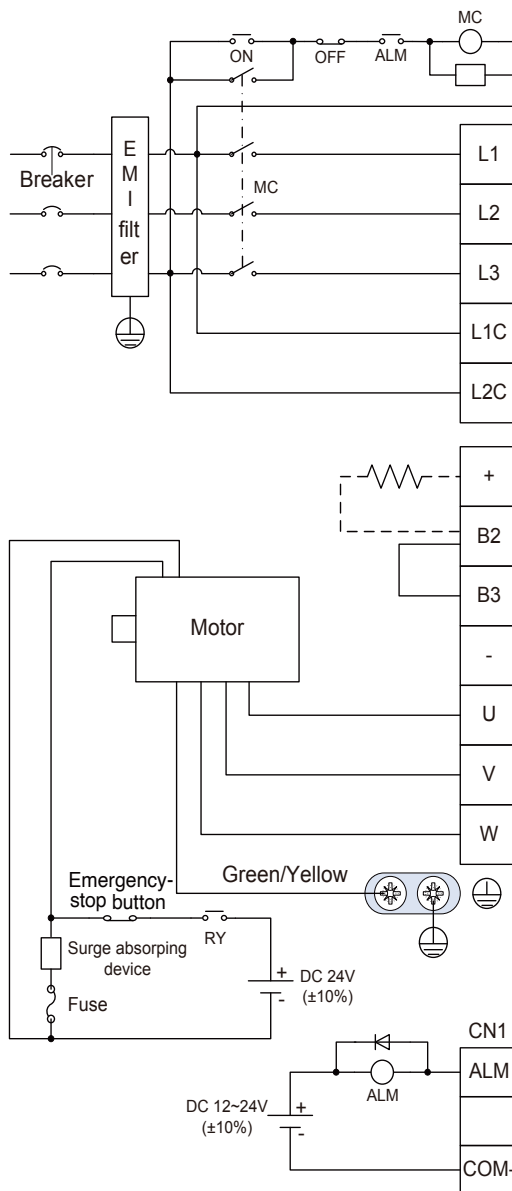

- The user is required to make this emergency stop protection circuit.
- Add surge absorbing devices on both ends of the electromagnetic contactor winding.
- Input voltage range of 400V system: AC 380V(-15%)~440V(+10%)

- It is necessary to connect external regenerative brake resistor between terminal (+) and PB

- Connect output U, V and W to the drive according to the motor cable phase sequence of servo motor, wrong phase sequence will cause drive fault

- Be sure to ground the servo drive to avoid accident of electrical shock.

- The electromagnetic brake uses 24V power supply which should be provided by the user. Moreover, it must be isolated from the DC12-24V power supply which is used by the control signal.

- Pay attention to the connection of the freewheeling diode. Reversed polarity may damage the drive.

## CN1

Applicable to the standard (pulse) type

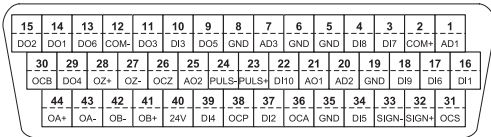

CN1 plug pin layout and signal layout

Applicable to EtherCAT and PROFINET bus communication

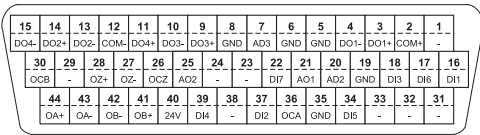

EtherCAT/PROFINET/PROFdrive CN1 plug pin layout and signal layout

## CN3

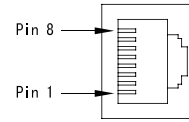

CN3 terminal function			
Pin	Name	Function	Remark
1	GND_CAN	CAN chip power GND	See the table on the left for definition if used as 485/CAN;
2	GND_485	485 chip power GND	
3	/	/	485 and CAN use the same interface and each signal has two pins for multiple networking.
4	RS485+	RS485 data+	
5	RS485-	RS485 data-	
6	/	/	
7	CAN_L	CAN data -	
8	CAN_H	CAN data+	

## CN2

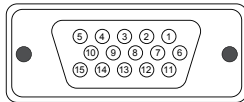

CN2 terminal function			
Pin	Name	Function	Remark
1	V+ / SD+	Parallel encoder V+ / Serial encoder data+	Different encoders use different cables
2	W+	Signal of parallel encoder W+	
3	A+	Signal of parallel encoder A+	
4	A-	Signal of parallel encoder A-	
5	5V	Encoder power supply	
6	U+	Signal of parallel encoder U+	
7	V- / SD-	Parallel encoder V- / Serial encoder data -	
8	W-	Signal of parallel encoder W-	
9	B-	Signal of parallel encoder B-	
10	B+	Signal of parallel encoder B+	
11	U-	Signal of parallel encoder U-	
12	GND	Power ground	
13	Z-	Signal of parallel encoder Z-	
14	Z+	Signal of parallel encoder Z+	
15	/	/	

## CN5

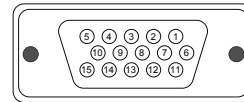

CN5 terminal function			
Pin	Name	Function	Remark
1	HWBB1+	Safety input 1+	Connect to grating ruler or 2 <sup>nd</sup> encoder
2	HWBB2+	Safety input 2+	
3	EXA+	Grating ruler (or 2 <sup>nd</sup> encoder) A+	
4	EXA-	Grating ruler (or 2 <sup>nd</sup> encoder) A-	
5	EX5V	Power+5V	
6	EDM+	Safety monitoring output+	
7	HWBB1-	Safety input 1-	
8	HWBB2-	Safety input 2-	
9	EXB-	Grating ruler (or 2 <sup>nd</sup> encoder) B-	
10	EXB+	Grating ruler (or 2 <sup>nd</sup> encoder) B+	
11	EDM-	Safety monitoring output-	
12	EX0V	Power GND, connect to internal GND	
13	EXZ-	Grating ruler (or 2 <sup>nd</sup> encoder) Z-	
14	EXZ+	Grating ruler (or 2 <sup>nd</sup> encoder) Z+	
15	/	/	

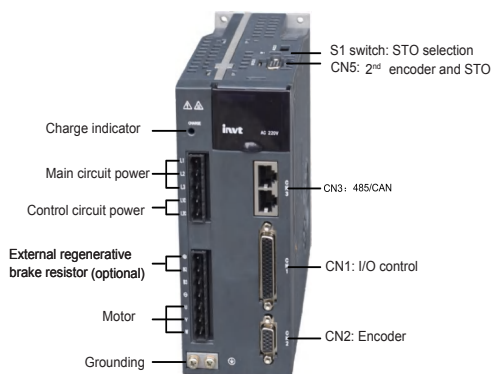

Frame sizes A, B, and C are the same in ports. Frame size B is taken for example.

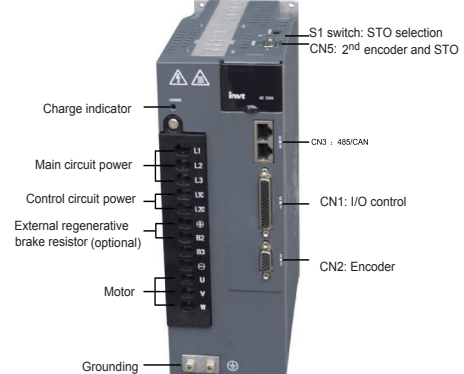

Frame size D



# Connection ports

Note: Standard-type examples

Medium power range: 7.5kW–55kW

## Wiring diagram of main circuit terminal

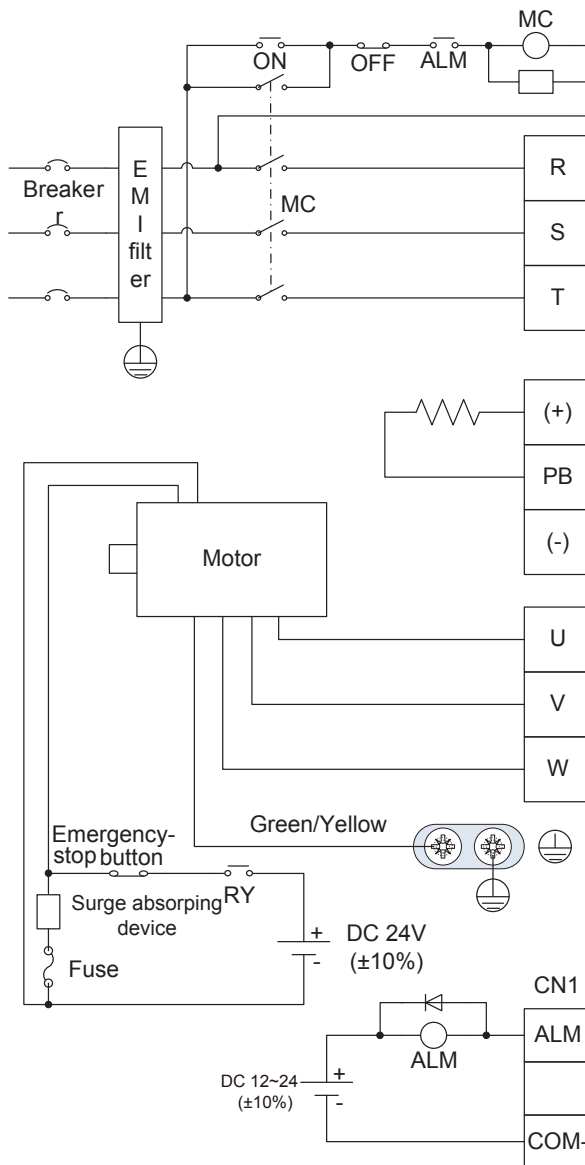

- The user is required to make this emergency stop protection circuit.
- Add surge absorbing devices on both ends of the electromagnetic contactor winding.
- Input voltage range of 400V system: AC 380V(-15%)~440V(+10%)

- It is necessary to connect external regenerative brake resistor between terminal (+) and PB

- Connect output U, V and W to the drive according to the motor cable phase sequence of servo motor, wrong phase sequence will cause drive fault

- Be sure to ground the servo drive to avoid accident of electrical shock.

- The electromagnetic brake uses 24V power supply which should be provided by the user. Moreover, it must be isolated from the DC12-24V power supply which is used by the control signal.

- Pay attention to the connection of the freewheeling diode. Reversed polarity may damage the drive.

## CN5

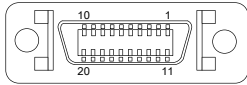

CN5 terminal function			
Pin	Name	Function	Remark
1	EXA+	Grating ruler (or 2 <sup>nd</sup> encoder) A+	Connect to grating ruler or 2 <sup>nd</sup> encoder
2	EXA-	Grating ruler (or 2 <sup>nd</sup> encoder) A-	
3	EXB+	Grating ruler (or 2 <sup>nd</sup> encoder) B+	
4	EXB-	Grating ruler (or 2 <sup>nd</sup> encoder) B-	
5	EXZ+	Grating ruler (or 2 <sup>nd</sup> encoder) Z+	
6	EXZ-	Grating ruler (or 2 <sup>nd</sup> encoder) Z-	
7, 9	EX5V	Power+5V	
8, 10	EX0V	Power GND, connect to internal GND	
11	HWBB1+	Safety input 1+	
12	HWBB1-	Safety input 1-	
13	EDM+	Safety monitoring output+	
14	EDM-	Safety monitoring output-	
15	HWBB2+	Safety input 2+	
16	HWBB2-	Safety input 2-	
17	OC_EXZ	Z phase open collector input	
18	OC_EXB	B phase open collector input	
19	OC_EXA	A phase open collector input	
20	-	Unused	

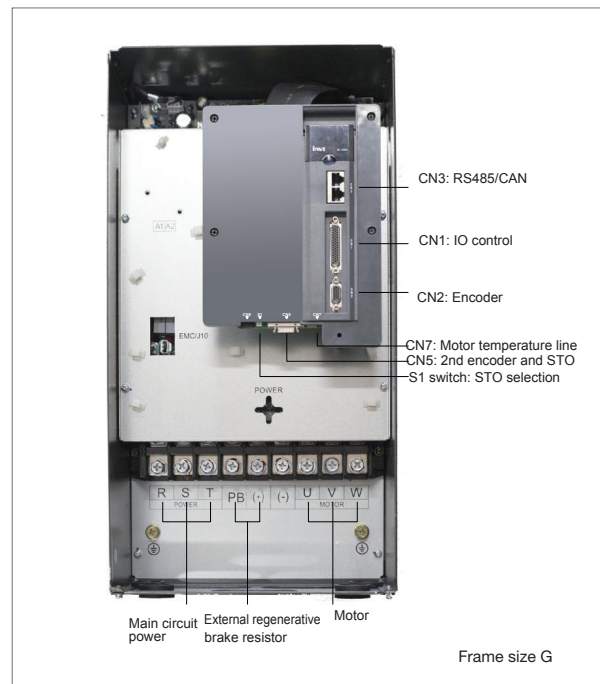
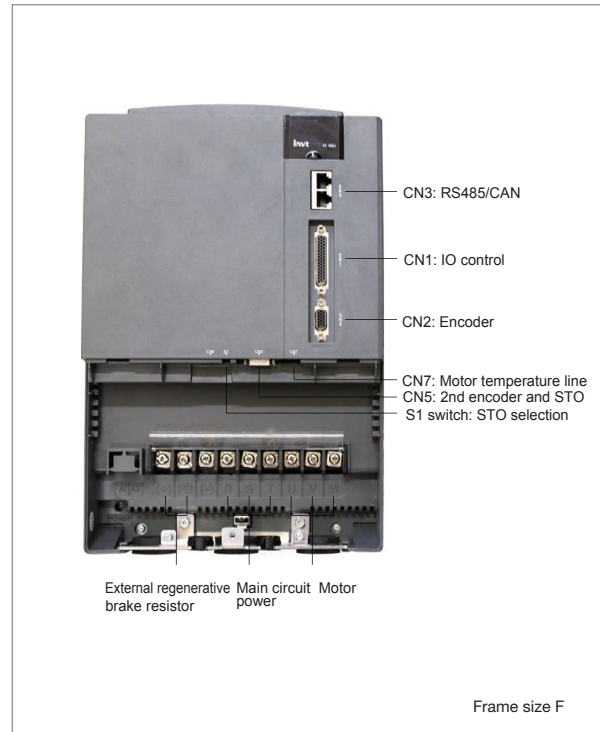

Remarks : The definitions of terminals CN1, CN2 and CN3 are the same for the small power models.

# System wiring

Frame size B is taken for example.

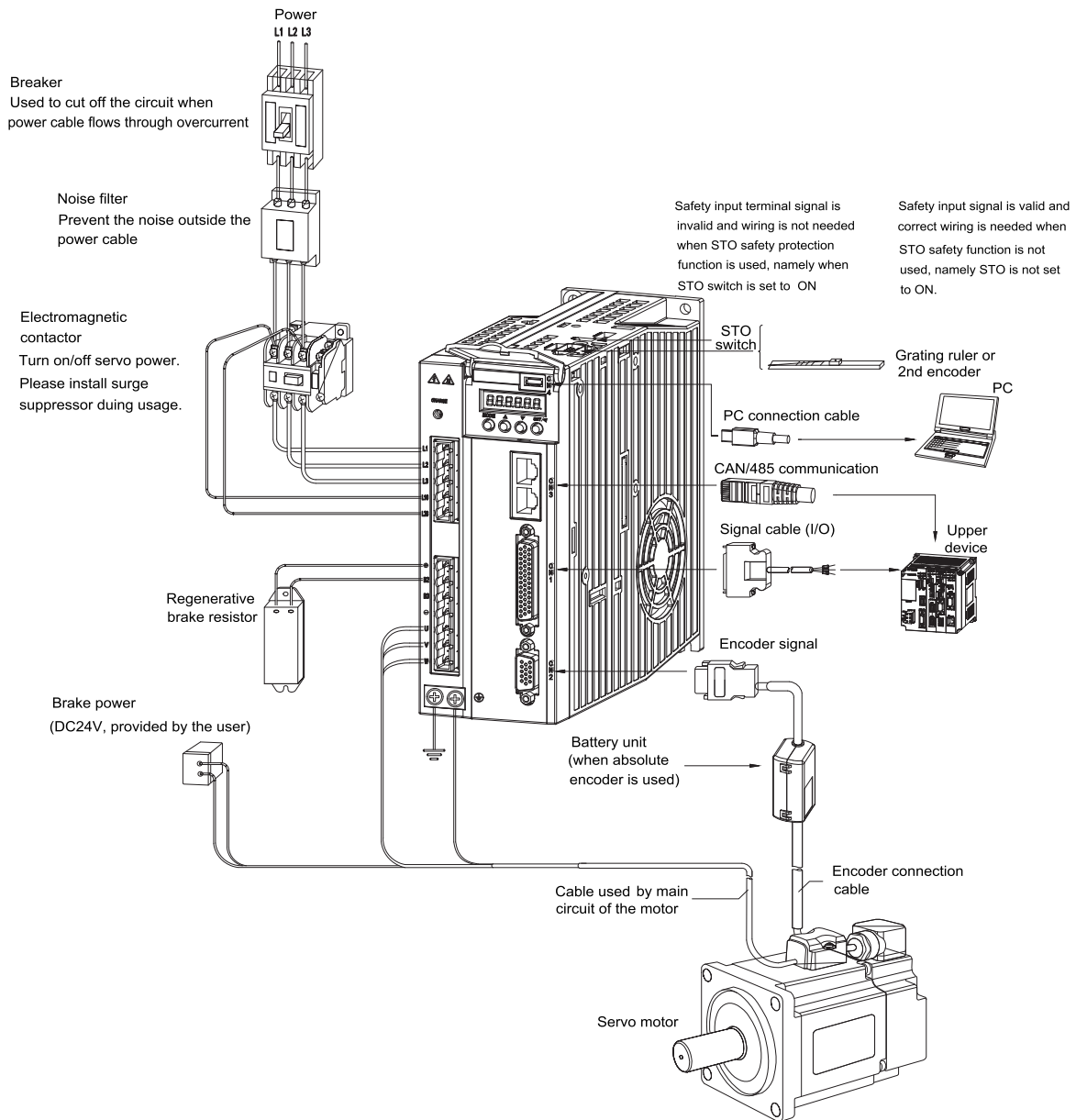

# Standard wiring diagram

## Wiring diagram of position mode (suitable for pulse input control)

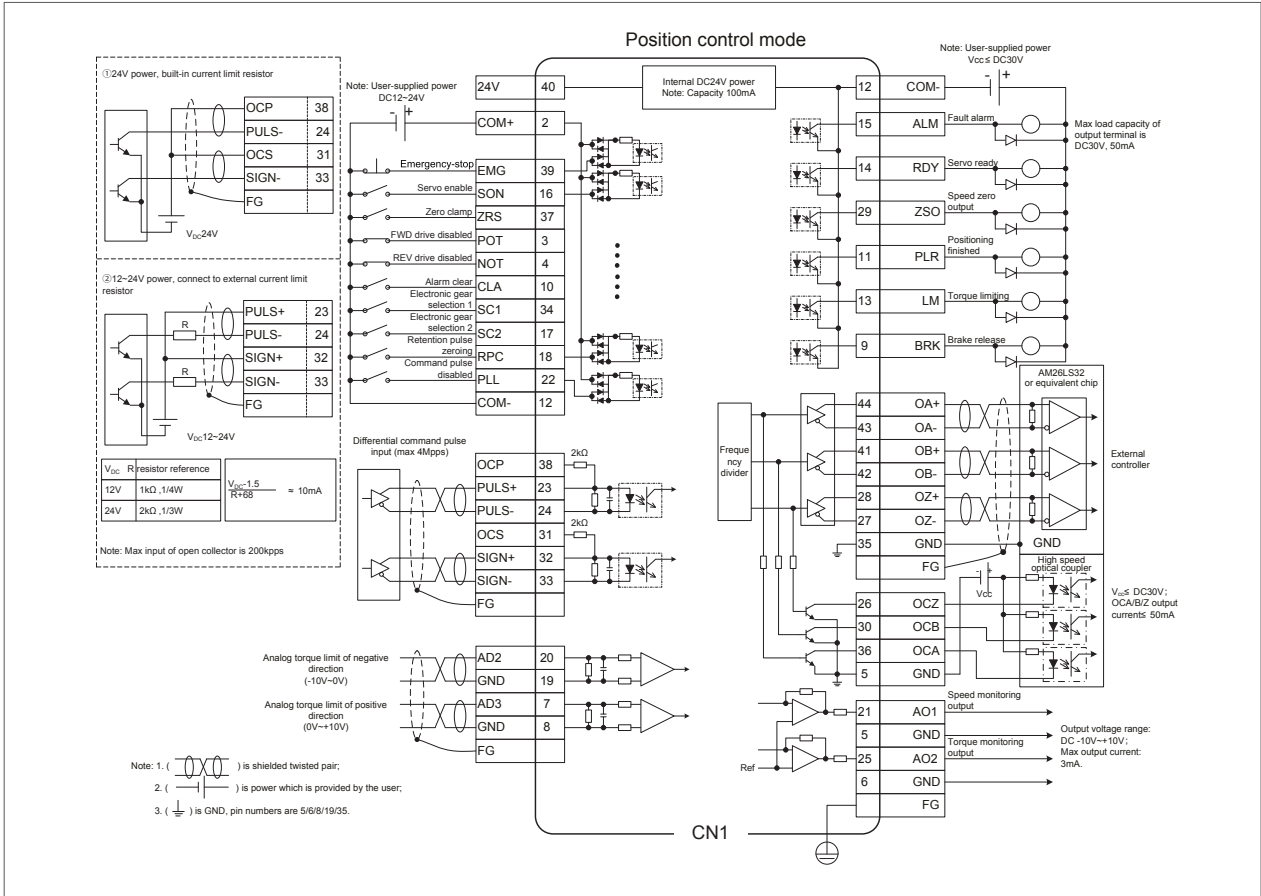

### CN1

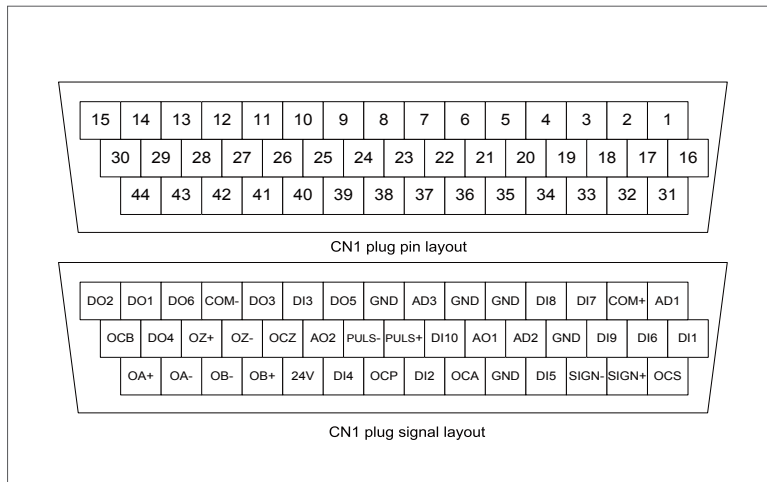

# Standard wiring diagram

## Wiring diagram of speed mode (suitable for analog input control)

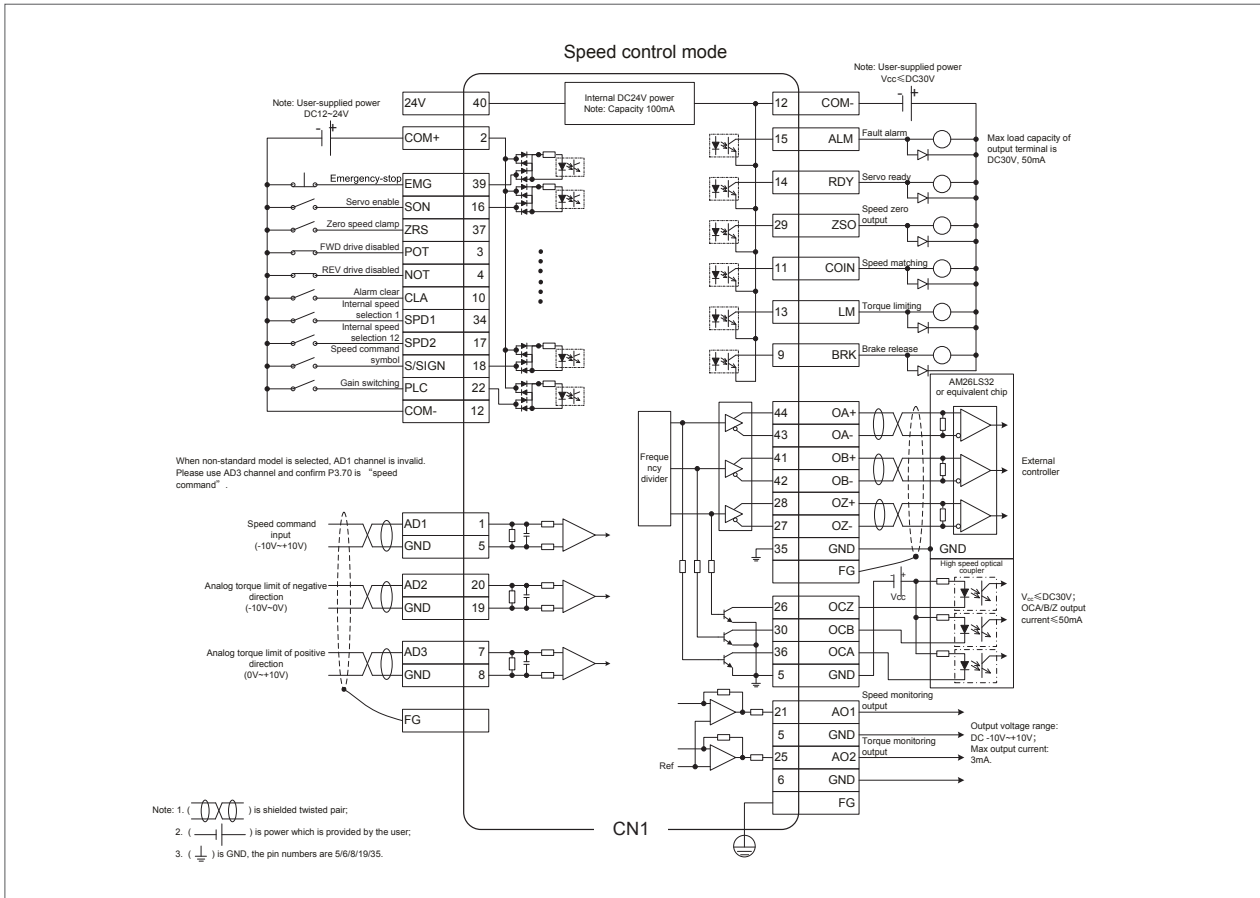

### CN1

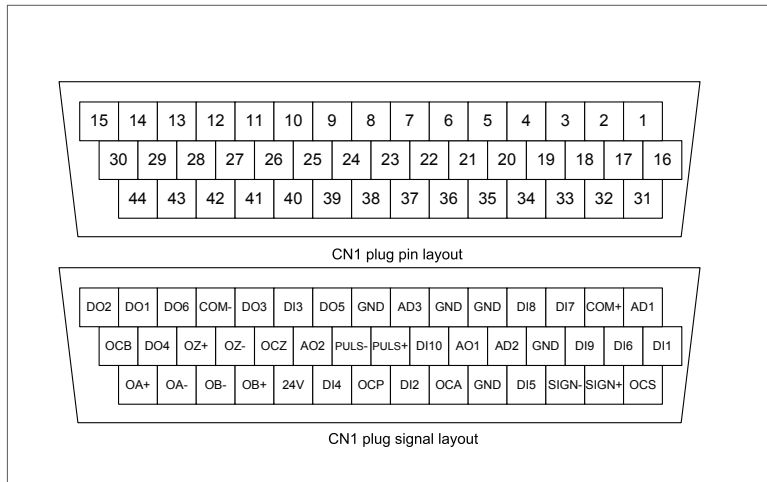

Wiring diagram of torque mode (suitable for analog input control)

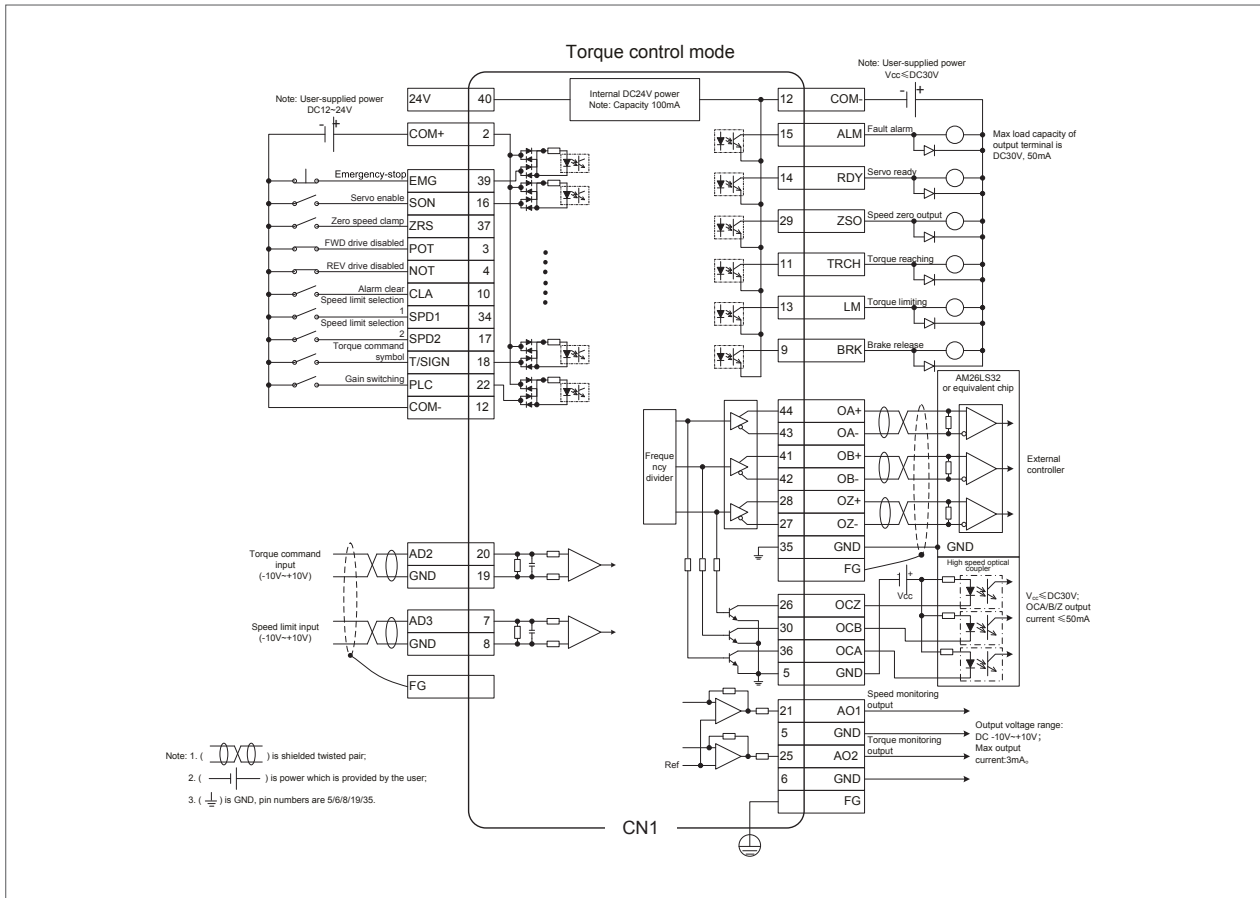

CN1

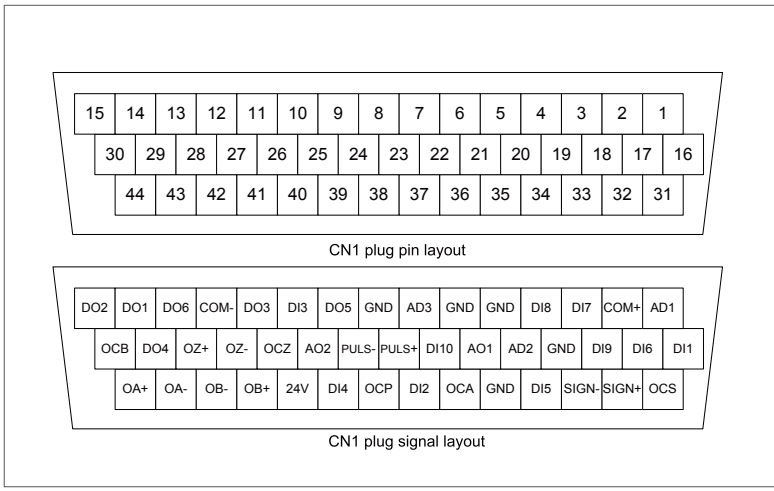

# Standard wiring diagram

## 2<sup>nd</sup> encoder and STO wiring diagram

Small power range: 100W–5.5kW

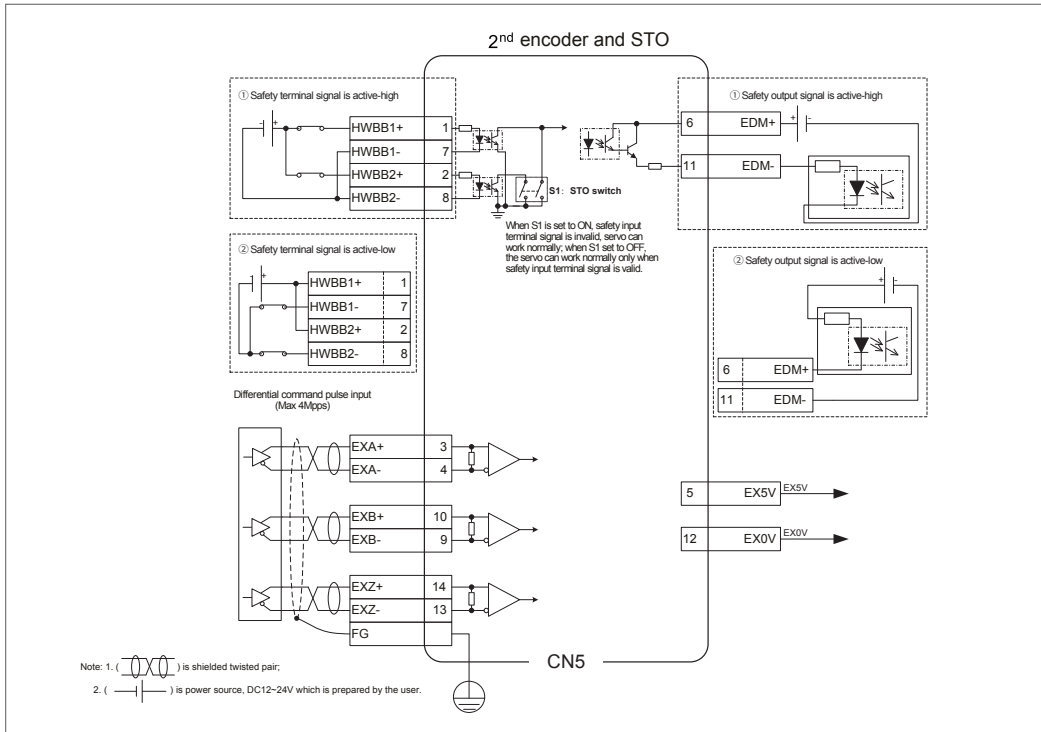

Medium power range: 7.5kW–55kW

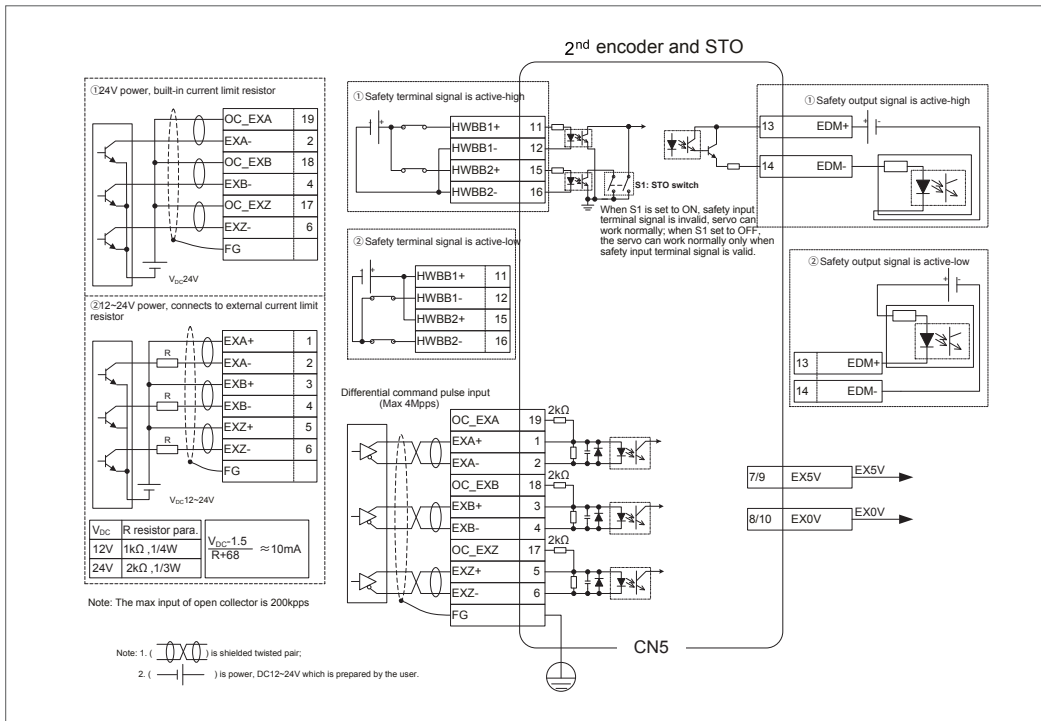



# Ordering guide for servo system

Model	DA200 series	Rated current(A)	Power cable	Encoder cable
IMS20A-04L10B30C-2-***	SV-DA200-0R2-2-**	1.8	DAML-050-xx-AFx-xx 	Magnetic & optical abs encoder DBEL-04-xx-Dx-04xx  Magnetic & optical abs encoder with battery DBEL-06-xx-Dx-04xx 
IMS20A-06M20B30C-2-***	SV-DA200-0R2-2-**	1.8		
IMS20A-06M40B30C-2-***	SV-DA200-0R4-2-**	3.3		
IMS20A-08M75B30C-2-***	SV-DA200-0R7-2-**	4.5		
IMS20A-08M10C25C-2-***	SV-DA200-1R0-2-**	5		
IMS20A-13M10C20C-2-***-A1	SV-DA200-1R0-2-**	5	DAML-100-xx-BFx-xx 	Magnetic & optical abs encoder DBEL-06-xx-Bx-04xx  Magnetic & optical abs encoder with battery DBEL-06-xx-Bx-04xx  Resolver DBEL-06-xx-Bx-07xx 
IMS20A-10M10C30C-2-***	SV-DA200-1R5-2-**	7.6		
IMS20A-13M15C20C-2-***-A1	SV-DA200-1R5-2-**	7.6		
IMS20A-13H85B15C-2-***-A	SV-DA200-1R5-2-**	7.6	DBML-250-xx-BWx-xx 	
IMS20A-10M15C30C-2-***	SV-DA200-2R0-2-**	10		
IMS20A-13M20C20C-2-***-A1	SV-DA200-2R0-2-**	10		
IMS20A-13H13C15C-2-***-A	SV-DA200-2R0-2-**	10	DAML-100-xx-BFx-xx 	
IMS20A-13H18C15C-2-***-A	SV-DA200-3R0-2-**	13		
IMS20A-13M30C20C-2-***-A1	SV-DA200-3R0-2-**	13		
IMS20A-10M10C30C-4-***	SV-DA200-1R0-4-**	3.5		
IMS20A-10M15C30C-4-***	SV-DA200-1R5-4-**	4.5		
IMS20A-10M20C30C-4-***	SV-DA200-2R0-4-**	6.5		
IMS20A-13M10C20C-4-***-A1	SV-DA200-1R0-4-**	3.5		
IMS20A-13M15C20C-4-***-A1	SV-DA200-1R5-4-**	4.5		
IMS20A-13M20C20C-4-***-A1	SV-DA200-2R0-4-**	6.5		
IMS20A-13H85B15C-4-***-A	SV-DA200-1R5-4-**	4.5		
IMS20A-13H13C15C-4-***-A	SV-DA200-1R5-4-**	4.5	DBML-250-xx-NWx-xx 	
IMS20A-13H18C15C-4-***-A	SV-DA200-2R0-4-**	6.5		
IMS20A-13M30C20C-4-***-A1	SV-DA200-3R0-4-**	8.5		
IMS20A-18M30C15C-4-***	SV-DA200-3R0-4-**	8.5	DBML-600-xx-NWx-xx 	
IMS20A-18M44C15C-4-***	SV-DA200-4R4-4-**	12		
IMS20A-18M55C15C-4-***	SV-DA200-5R5-4-**	16	DAML-10R-xx-SSx-xx 	
IMS20A-18M75C15C-4-***	SV-DA200-7R5-4-**	25		
IMS20A-20M11D18C-4-***	SV-DA200-011-4-**	33	DAML-16R-xx-SSx-xx 	
IMS20A-20M16D20C-4-***	SV-DA200-011-4-**	33		
IMS20A-20M18D18C-4-***	SV-DA200-015-4-**	50	DAML-25R-xx-SSx-xx 	
IMS20A-20M25D18C-4-***	SV-DA200-022-4-**	66		
IMS20A-26M41D20C-4-***	SV-DA200-037-4-**	90	DAML-25R-xx-SSx-xx 	
IMS20A-26M48D20C-4-***	SV-DA200-045-4-**	112		
IMS20A-26M56D20C-4-***	SV-DA200-055-4-**	134		
IMS20A-26M64D20C-4-***	SV-DA200-055-4-**	134		

Remark: xx refer to page 27-30 ,cable manual

# / Other INVT industrial control products



## ■ PLC

- Complete categories for wide applications
- Abundant extension modules for easy function extension
- Support for various communication protocols, flexible networking
- Compact size for easy maintenance



## ■ Linear motor drive

- Support for magnetic pole alignment of linear motors without auxiliary signal
- Support for various grating and magnetic rulers
- Stronger torque output and quicker dynamic response, without intermediate drive
- Closed-loop feedback control on linear position detection, with high accuracy positioning in short time and high dynamic rigidity
- Parameter unit consistency in commissioning interface, without conversion
- Short ACC/DEC and high efficiency of drive, without travel limit



## ■ Motion controller

- Various motion controller cards
- All series motion controller
- Robot control system
- Customized digital control system



## ■ VFD

- The most comprehensive inverter lines in the industry, covering from low, medium to high voltage VFDs
- Customized products based on customer needs are available



## ■ DL310 DC Low voltage servo drive

- It is widely used in logistics, textile and other special industries.

# “One-stop” service

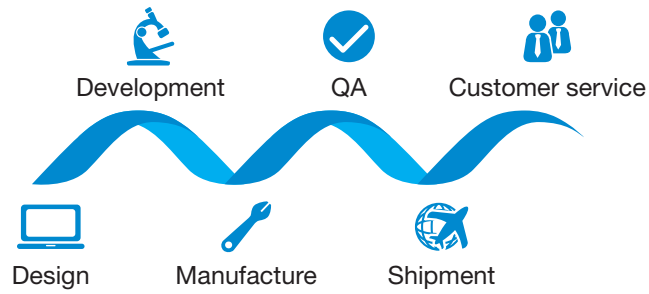

# Service network

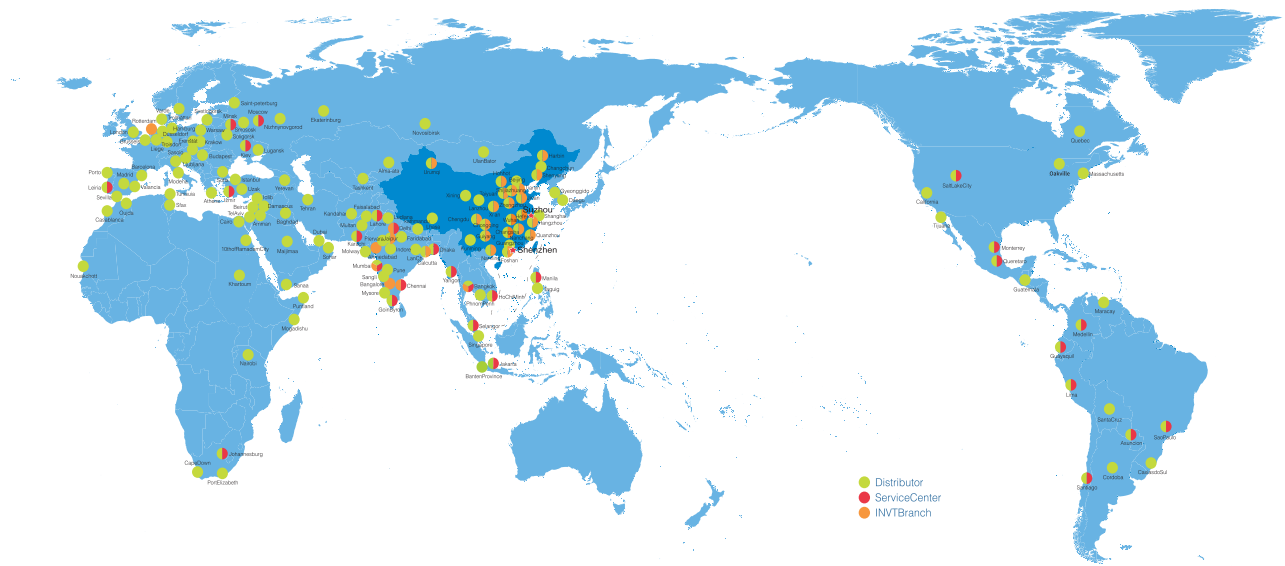

*Your trusted industry automation solution provider*

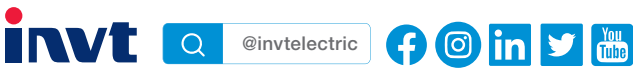
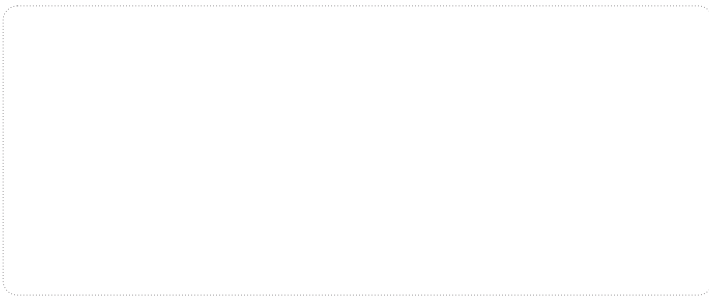

E-mail: [overseas@invt.com.cn](mailto:overseas@invt.com.cn) Website: [www.invt.com](http://www.invt.com)

SHENZHEN INVT ELECTRIC CO.,LTD. INVT Guangming Technology Building, Songbai Road, Matian, Guangming District, Shenzhen, China

- |                               |  |                                       |                            |                                   |
|-------------------------------|--|---------------------------------------|----------------------------|-----------------------------------|
| <b>Industrial Automation:</b> | • Frequency AC Drive                         | • Servo & Motion Control              | • Motor & Electric Spindle | • PLC                             |
|                               | • HMI  | • Intelligent Elevator Control System | • Traction Drive           |                                   |
| <b>Electric Power:</b>        | • SVG  | • Solar Pump Controller               | • UPS                      | • Online Energy Management System |
|                               | • New Energy Vehicle Electric Control System |                                       |                            |                                   |

INVT Copyright.  
Information may be subject to change without notice during product improving.

66003-00104 202402(V5.4)