

INVT Control Level Product Catalog

Programmable Controller / Human Machine Interface / Industrial Internet

Your Trusted Industry Automation Solution Provider

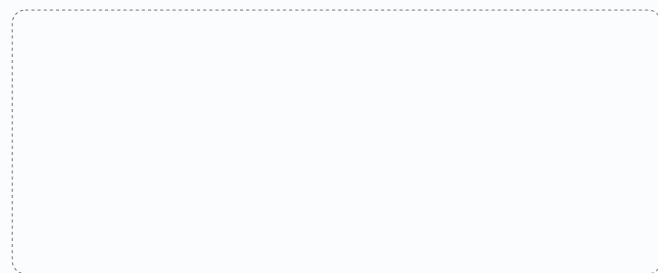

Service line: 86-755-23535967 E-mail: overseas@invt.com.cn Website: www.invt.com

SHENZHEN INVT ELECTRIC CO.,LTD. INVT Guangming Technology Building, Songbai Road, Matian, Guangming District, Shenzhen, China

Industrial Automation:

- HMI
- PLC
- VFD
- Servo System
- Elevator Intelligent Control System
- Rail Transit Traction System

Electric Power:

- UPS
- DCIM
- Solar Inverter
- New Energy Vehicle Powertrain System
- New Energy Vehicle Charging System
- New Energy Vehicle Motor

INVT Copyright.
Information may be subject to change without notice during product improving.

20220520 (V1.0)



CONTENT

Company profile

INVT (Shenzhen INVT Electric Co., Ltd) has been concentrating on industry automation and energy power since its foundation in 2002 and is committed to "Providing the best product and service to allow customers more competitiveness". INVT goes public in 2010 and is the first A-share listed company (002334) in Shenzhen Stock Exchange in the industry. At present, INVT owns 15 subsidiaries and more than 3200 employees, over 30 domestic offices and warranty centers and 4 overseas branches, forming a sales network covering more than 100 overseas countries and regions.

INVT has been awarded as the Key High-tech Enterprise of National Torch Plan based on mastering of key technologies in power electronics, auto control and IT. With business covering industry automation, electric vehicle, network power and rail transit, INVT has established 12 R&D centers nationwide, boasts more than 1300 patents and owns the first lab in the industry awarded ACT qualification from TÜV SÜD, UL-WTDP and

CNAS National Lab. The industrial parks in Shenzhen and Suzhou aim to provide customers with advanced integrated product development design management, comprehensive product R&D test and auto informational production. The worldwide INVT branches and warranty service centers are ready to offer customers all-around back-ups including professional solutions, technical trainings and service support.

In the next decade, INVT will continue to take "Honesty and Integrity, Professionalism and Excellence" as our business philosophy, enhance core business sectors including industrial automation, electric vehicle, network power and rail transit based on the three major technologies in industry automation and energy power fields, and strive to become a leading, responsible and harmonic international professional group armed with proper product structure, leading technologies, efficient management, robust profitability and superior competitiveness.



P3 | **Small PLC**



P33 | **Medium PLC**



P41 | **Distributed I/O module**



P43 | **HMI**

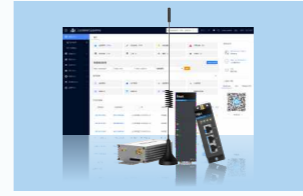

P51 | **Industrial Internet**

INVT Automation networking

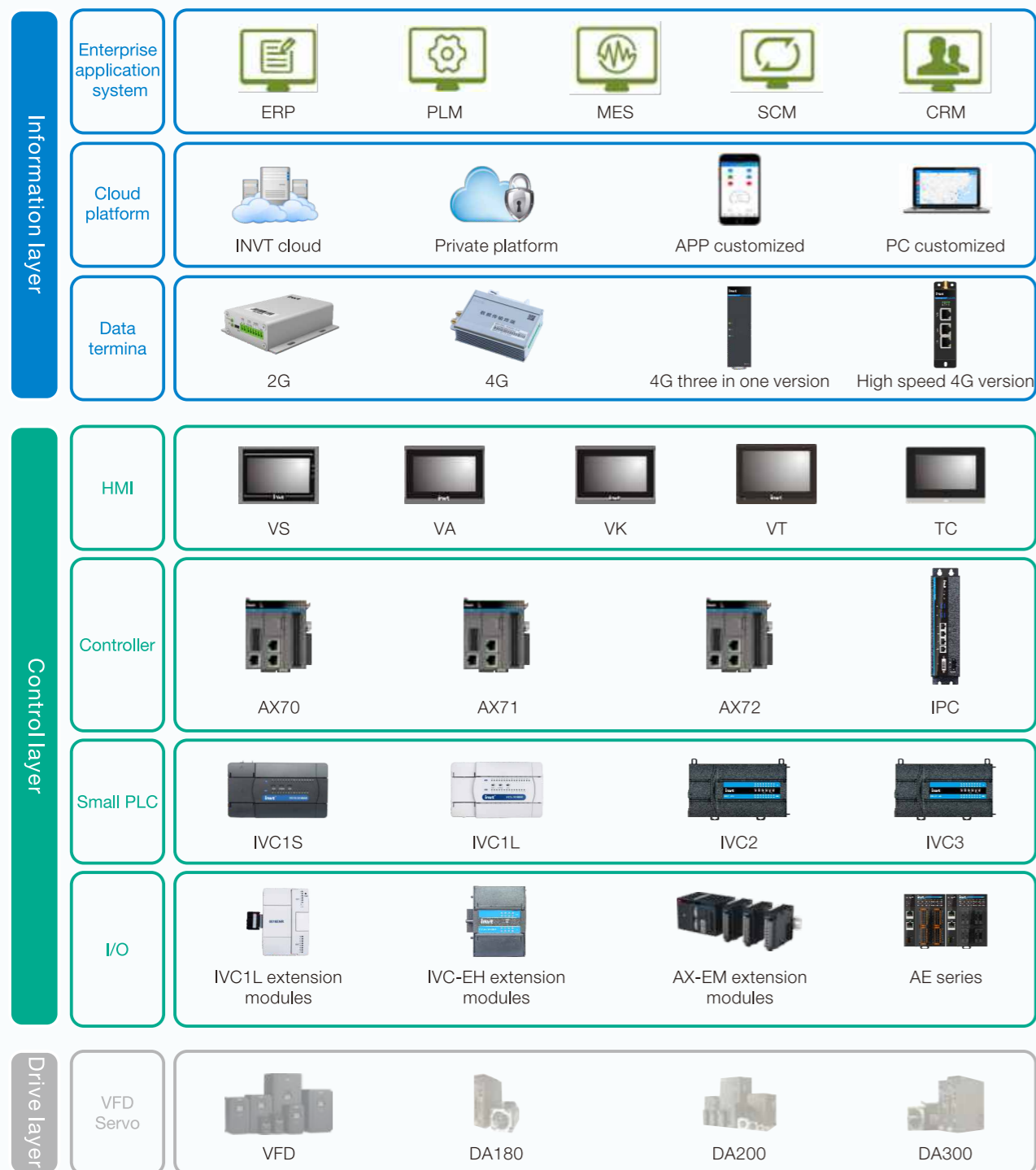

Small PLC

IVC series PLC features fast speed, stable performance, strong function and software usability.



High speed I/O

High speed counter+pulse output

The frequency of high speed counter is detected by SPD instruction.
Adjust pulse frequency to make the master and slave axes synchronous.

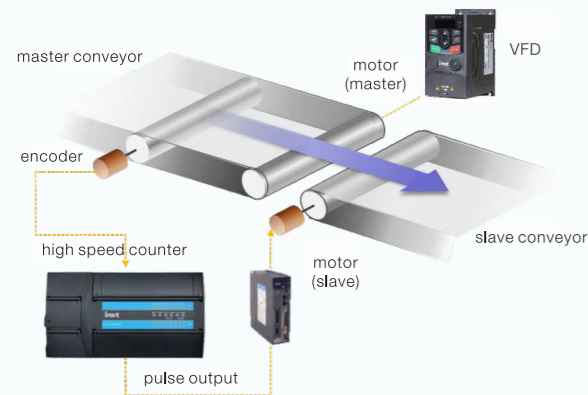

Built-in PWM output

Pulse output port can be used as PWM output.
Simplified analog voltage output can be obtained by adding smooth capacitor circuit.

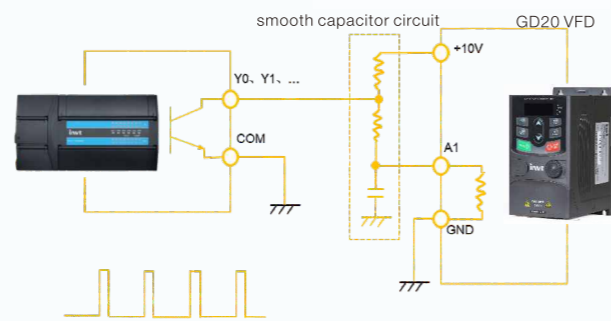

The PWM instruction can adjust the pulse width to control the speed of VFD

Built-in E-CAM function

The electric cam function utilizes the preset cam curve to determine the movement amount of the slave axis according to the action of the master axis and the cam curve, which can replace the old type cam machine structure.

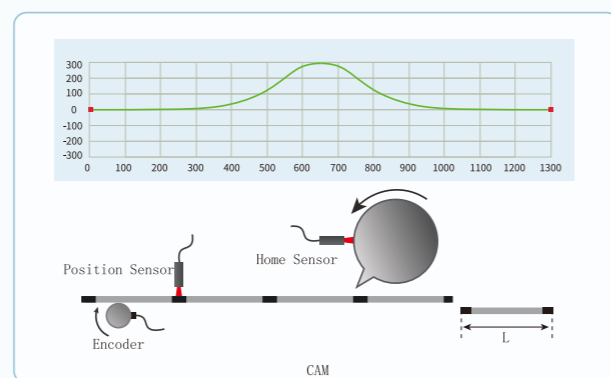

Serial communication

- Built-in RS232 and RS485 interface, supporting MODBUS master/slave protocol.
- USB2.0 programming port supports uploading, downloading, monitoring and debugging functions.

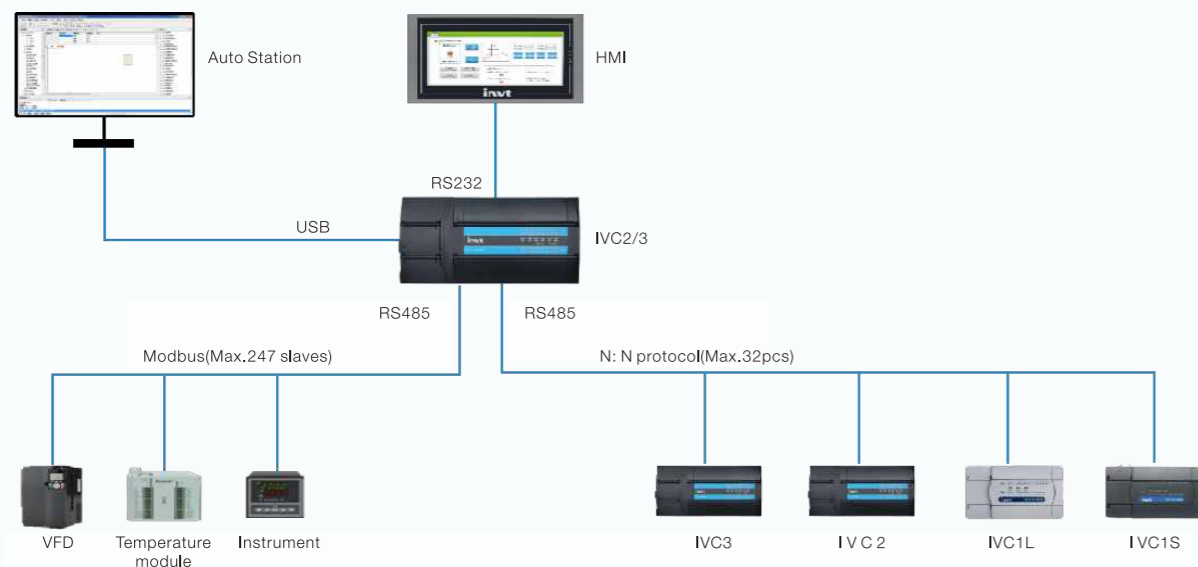

Ethernet communication

- Programming protocol
Support uploading and downloading program, monitoring and debugging.
- Modbus TCP protocol
Support Modbus TCP master/slave protocol, and can make the communication with kinds of instrument, HMIs and inverters realizing data exchange.

Ethernet Interface	Features
	RJ45/100Mbps
Protocol	Modbus TCP (port: 502) Programming protocol (port: 9016)
MODBUS TCP	As a master, supporting up to 16 slaves As a slave, supporting up to 4 masters

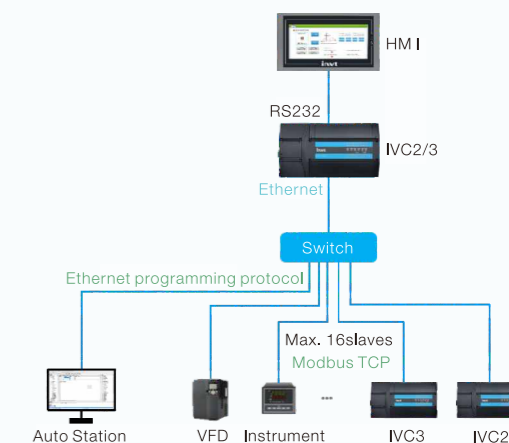

CANOpen communication

- Support DS301 protocol and multi-axis PTP and speed control via CANOpen.

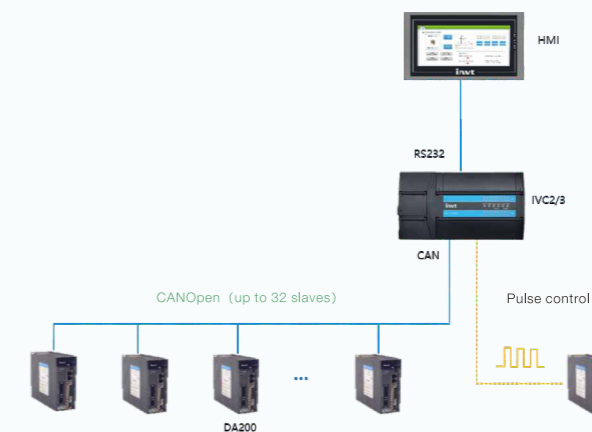

IVC Series PLC Type Definition:

IVC1L-3624-MAT*
① ② ③ ④ ⑤ ⑥ ⑦

Sign	Content
Product Series	IVC1S: Economic IVC2/IVC3: Advanced IVC1L: General
Input	36: 36 input
Output	24: 24 output
Module type	M: main module
Power supply	A: 200VAC D: 24VDC
Output type	T: transistor R: relay
Special type	IVC1L Series: -1: 2AI and 1AO IVC3 Series: -4: 4 axes high speed pulse output -6: 2 thermal resistor -M: motion control

IVC1S feature

IVC1S is an economical, small PLC, with highly integrated functions and high cost performance in small-sized IO applications.

- Maximum 60 I/O points and doesn't support extension I/O
- 6K step program capacity
- 1 RS232 and 1 RS485, support MODBUS master/slave protocol
- 6 10K high speed input
- 2 100K high speed output (transistor type)
- No real clock time function
- Non-detachable terminal



IVC1S technical specification

Model	IVC1S-	1006MAT	1410MAT	1614MAT	2416MAT	3624MAT	1006MAR	1410MAR	1614MAR	2416MAR	3624MAR	
Power supply												
Input	Voltage	220VAC(85~264VAC)										
	Current	0.5A										
Output	24V/COM	250mA										
I/O configuration												
Built-in I/O	Total	16	24	30	40	60	16	24	30	40	60	
	Inputs	10	14	16	24	36	10	14	16	24	36	
	Outputs	6	10	14	16	24	6	10	14	16	24	
	Input type	NPN/PNP					NPN/PNP					
	Output type	Transistor (NPN)					Relay					
High speed I/O												
High speed input	6×10KHz, 2×5KHz (AB phase)					6×10KHz, 2×5KHz (AB phase)						
High speed output	2×100KHz					-						
Communication												
Serial port	RS232	1					-					
	RS485	1					-					
	Protocol	programming protocol; MODBUS master/slave; free port; N:N protocol										
Storage												
Program capacity	6K step											
Data block	8000 D registers											
Interrupt												
External input interrupt	16											
High speed counter interrupt	6											
Internal time interrupt	3											
Serial port interrupt	4											
PTO output completion interrupt	2											
Power loss interrupt	1											
Programming												
Software	Auto Station											
Subprogram calling	Supported total 64 subprograms (6 levels), and it can supports the design of input and output interfaces											
Others												
Digital filtering function	X0~X7 adopts digital filtering and other ports adopt hardware filtering											
Encryption	Upload/download password, monitor password, subprogram encryption, format disable, upload disable											
Real time clock	-											
Data saving function at power failure	Support											
Soft element												
Inputs	X element, 128											
Outputs	Y element, 128											
Auxiliary relays	M element, 2048											
Local auxiliary relays	LM element, 64											
Special auxiliary relays	SM element, 512											
Status relays	S element, 1024											
Data registers	D element, 8000											
Local data registers	V element, 64											
Indexing/addressing registers	Z element, 16											
Special data registers	SD element, 512											

Model	IVC1S-	1006MAT	1410MAT	1614MAT	2416MAT	3624MAT	1006MAR	1410MAR	1614MAR	2416MAR	3624MAR
Soft element											
Timer	Total	T element, 256									
	1ms	T252~T255									
	10ms	T210~T251									
	100ms	T0~T209									
Counter	Total	C element, 256									
	16bit up counter	C0~C199									
	32bit up/down counter	C200~C235									
	32bit high speed counter	C236~C255									
Rising edge	1024										
Falling edge	1024										

IVC1S dimension

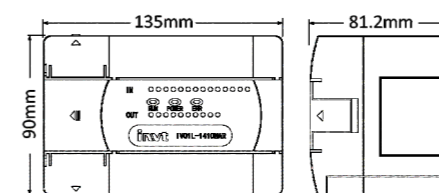

Model	Dimension
IVC1S-1006M** IVC1S-1410M**	135×90×81.2mm

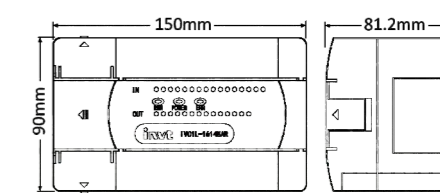

Model	Dimension
IVC1S-1614M**	150×90×81.2mm

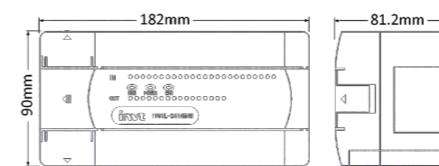

Model	Dimension
IVC1S-2416M**	182×90×81.2mm

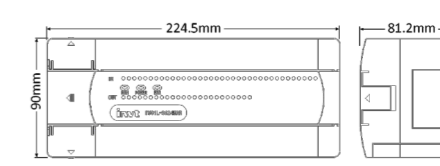

Model	Dimension
IVC1S-3624M**	224.5×90×81.2mm

IVC1S wiring diagram

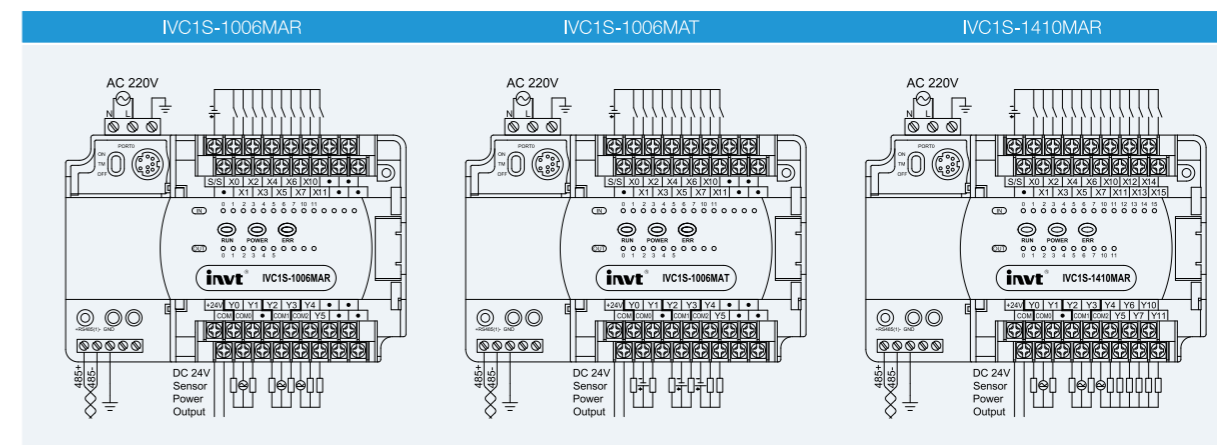

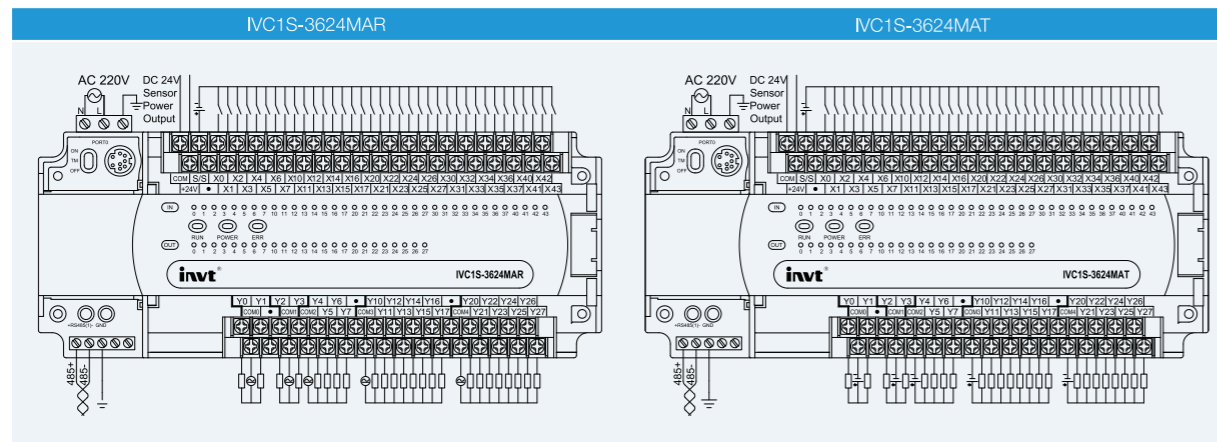
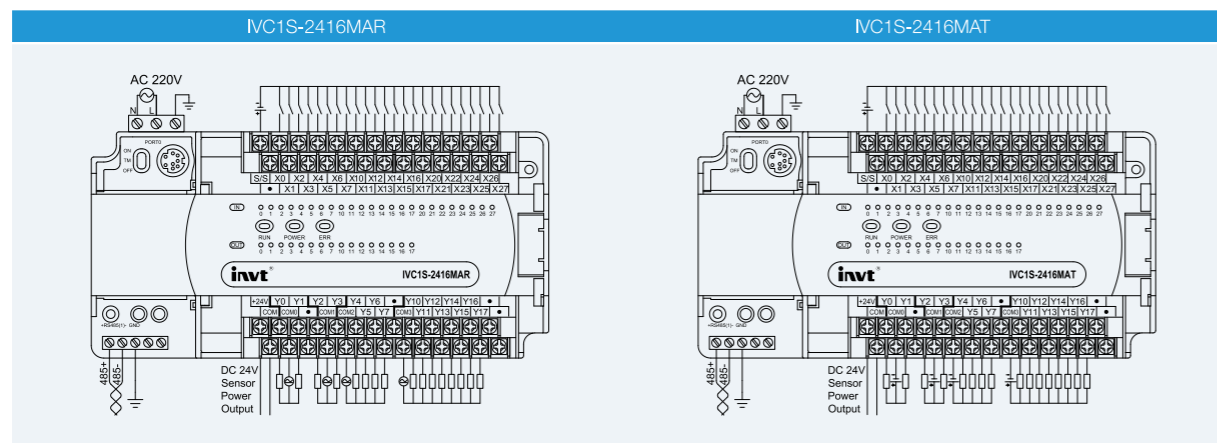
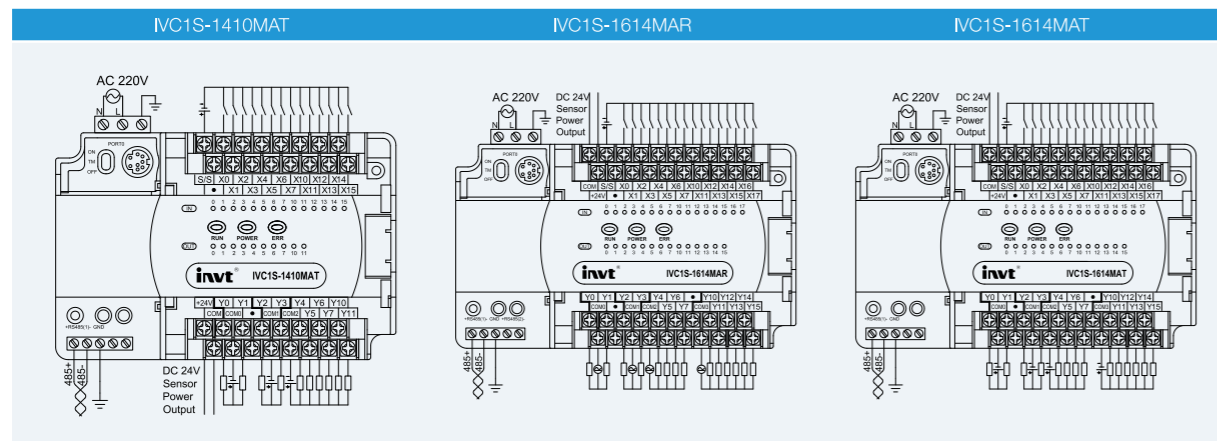

IVC1L feature

IVC1L is a general-purpose PLC product with compact structure, complete functions, and flexible I/O configuration. It can be widely used in small-scale IO and simple positioning applications.

- 60 built-in I/O, able to add on 7 modules and 128 I/O
- 16K step program capacity
- 1 RS232, 2 RS485, supporting the Modbus master/slave protocol
- 2 50K+4 10K high speed input
- 3 100K high speed output (transistor type)
- Support real time clock function and built-in battery
- Support DC power supply and AC power supply modules



IVC1L technical specification

Model	IVC1L-	0806MAT	1410MAT	1614MAT	1614MAT1	2416MAT	3624MAT	0806MAR	1410MAR	1614MAR	2416MAR	3624MAR
Power												
Input	Voltage	220VAC (85~264VAC)										
	Current	1.5A										
Output	5V/GND	900mA										
	24V/GND	300mA										
	24V/COM	600mA										
I/O configuration												
Built-in I/O	Total	14	24	30	30	40	60	14	24	30	40	60
	Input	8	14	16	16	24	36	8	14	16	24	36
	Output	6	10	14	14	16	24	6	10	14	16	24
	Input type	NPN/PNP						NPN/PNP				
Output type	Transistor (NPN)						Relay					
Extension I/O	Extension module	7										
	Total	128										
Analog												
		-					2 AI, 1 AO		-			
High speed I/O												
High speed input		2×50KHz+4×10KHz, AB phase (1×30K, 1×5K)						2×50KHz+4×10KHz, AB phase (1×30K, 1×5K)				
High speed output		3×100KHz						-				
Communication												
Serial port	RS232	1										
	RS485	2										
	Protocol	Programming protocol; MODBUS master/slave; free port; N:N protocol										
Storage												
Program capacity		16K step										
Data block		8000 D registers										
Interrupt												
External input interrupt		16										
High speed counter interrupt		6										
Internal time interrupt		3										
Serial port interrupt		12										
PTO output completion interrupt		3										
Power loss interrupt		1										
Programming												
Software		Auto Station										
Subprogram calling		Supported total 64 subprograms (6 levels), and it can supports the design of input and output interfaces										
Others												
Digital filtering function		X0~X7 adopts digital filtering and other ports adopt hardware filtering										
Encryption		Upload/download password, monitor password, subprogram encryption, format disable, upload disable										
Real time clock		Support, built-in battery										
Data saving function at power failure		Support										

IVC1L technical specification

Model	IVC1L-	0806MDT	1410MDT	1614MDT	2416MDT	3624MDT	0806MDR	1410MDR	1614MDR	2416MDR	3624MDR	1614MAR	1616MAR6
Power													
Input	Voltage	24VDC (19~30VDC)										220VAC (85~264VAC)	
	Current	0.85A										15A	
Output	5V/GND	900mA											
	24V/GND	300mA											
	24V/COM	-										600mA	
I/O configuration													
Built-in I/O	Total	14	24	30	40	60	14	24	30	40	60	30	32
	Input	8	14	16	24	36	8	14	16	24	36	16	16
	Output	6	10	14	16	24	6	10	14	16	24	14	16
	Input type	NPN/PNP						NPN/PNP					
Extension I/O	Output type	Transistor (NPN)						Relay					
	Extension module	7											
Analog	Total	128											
												2 AI, 1 AO 2 thermal resistance	
High speed I/O													
High speed input	2x50KHz+4x10KHz, AB phase (1x30K, 1x5K)						2x50KHz+4x10KHz, AB phase (1x30K, 1x5K)						
High speed output	3x100KHz						-						
Communication													
Serial port	RS232	1											
	RS485	2											
	Protocol	Programming protocol; MODBUS master/slave; free port; N:N protocol											
Storage													
Program capacity	16K step												
Data block	8000 D registers												
Interrupt													
External input interrupt	16												
High speed counter interrupt	6												
Internal time interrupt	3												
Serial port interrupt	12												
PTO output completion interrupt	3												
Power loss interrupt	1												
Programming													
Software	Auto Station												
Subprogram calling	Supported total 64 subprograms (6 levels), and it can supports the design of input and output interfaces												
Others													
Digital filtering function	X0~X7 adopts digital filtering and other ports adopt hardware filtering												
Encryption	Upload/download password, monitor password, subprogram encryption, format disable, upload disable												
Real time clock	Support, built-in battery												
Data saving function at power failure	Support												
IVC1L													
Soft element													
Inputs	X element, 128												
Outputs	Y element, 128												
Auxiliary relays	M element, 2048												
Local auxiliary relays	LM element, 64												
Special auxiliary relays	SM element, 512												
Status relays	S element, 1024												
Data registers	D element, 8000												
Local data registers	V element, 64												
Indexing/addressing registers	Z element, 16												
Special data registers	SD element, 512												
Timer	Total	T element, 256											
	1ms	T252~T255											
	10ms	T210~T251											
	100ms	T0~T209											
Counter	Total	C element, 256											
	16bit up counter	C0~C199											
	32bit up/down counter	C200~C235											
	32bit high speed counter	C236~C255											
Rising edge	1024												
Falling edge	1024												

IVC1L dimension

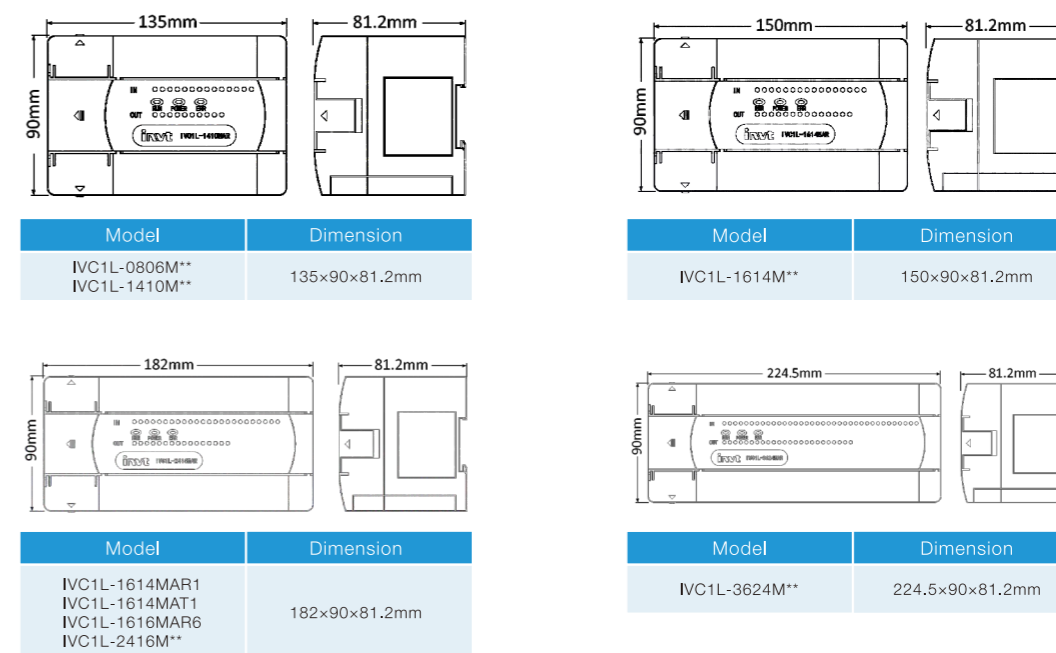

IVC1L(AC) wiring diagram

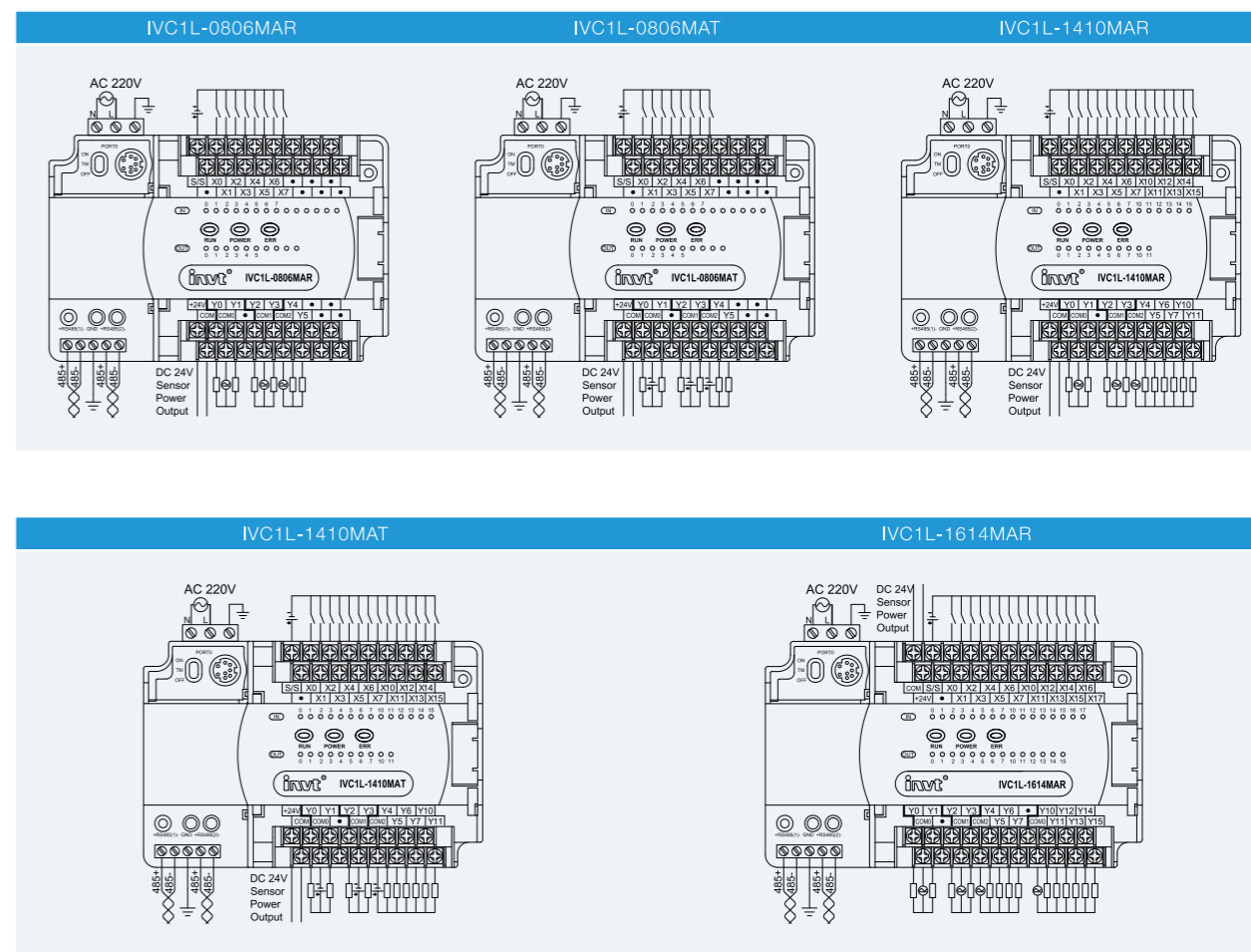

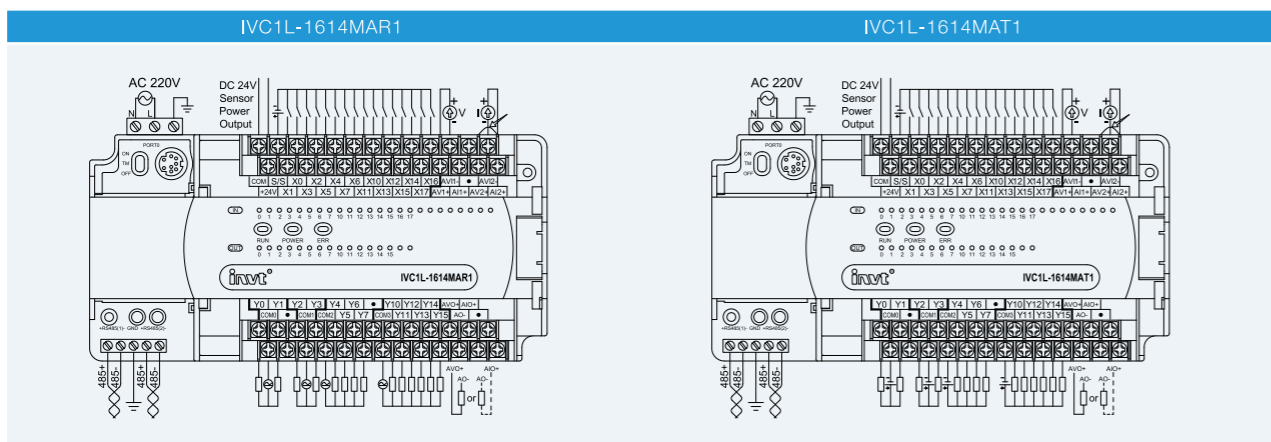
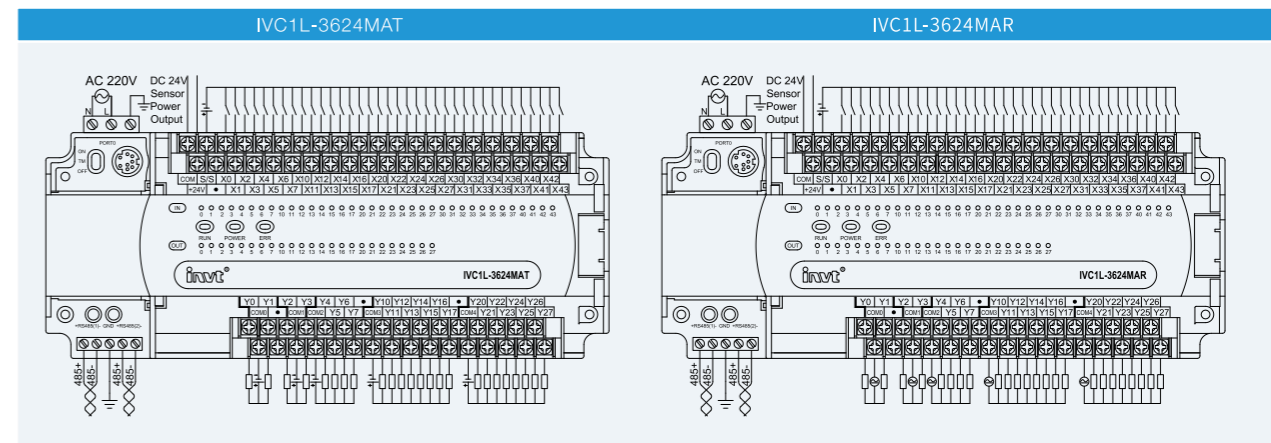
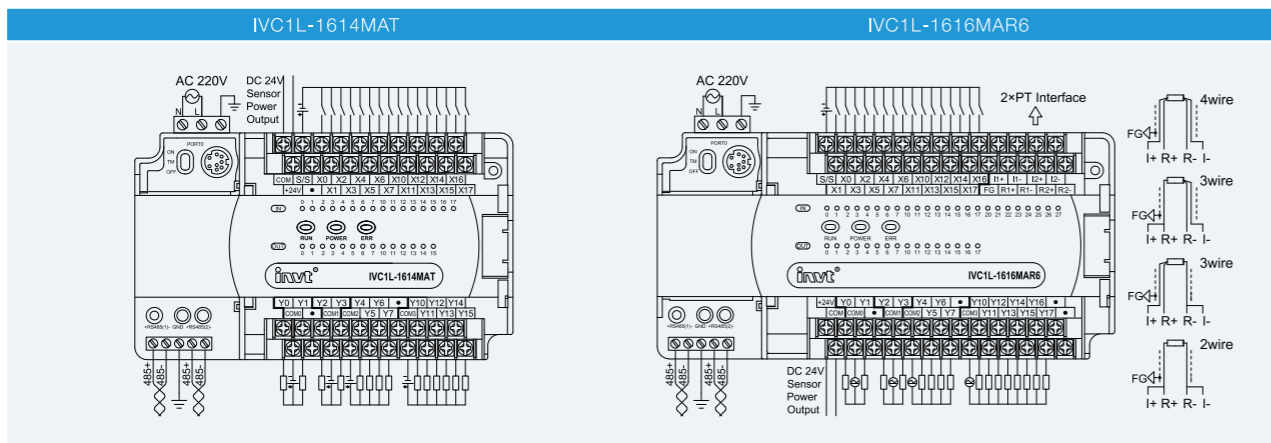

IVC1L(DC) wiring diagram

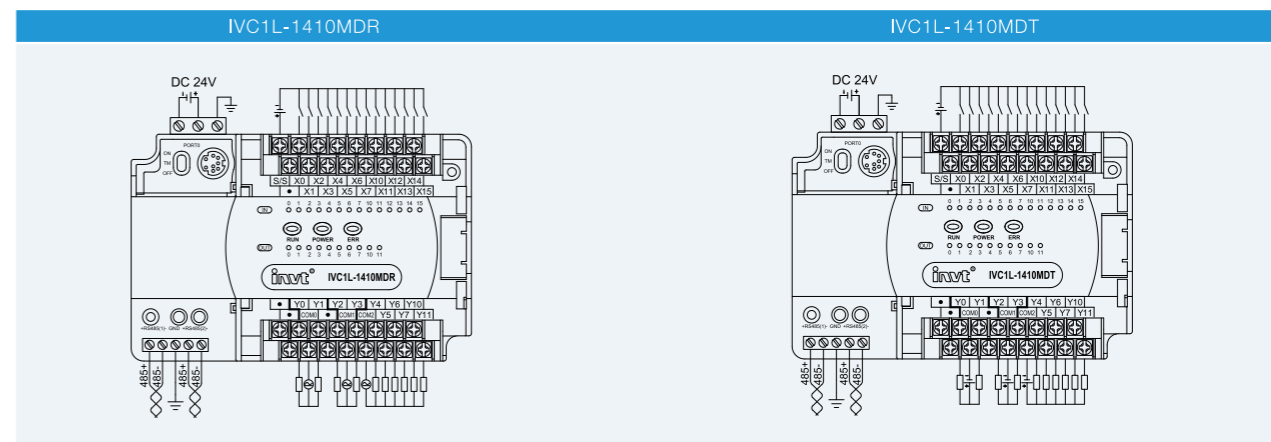
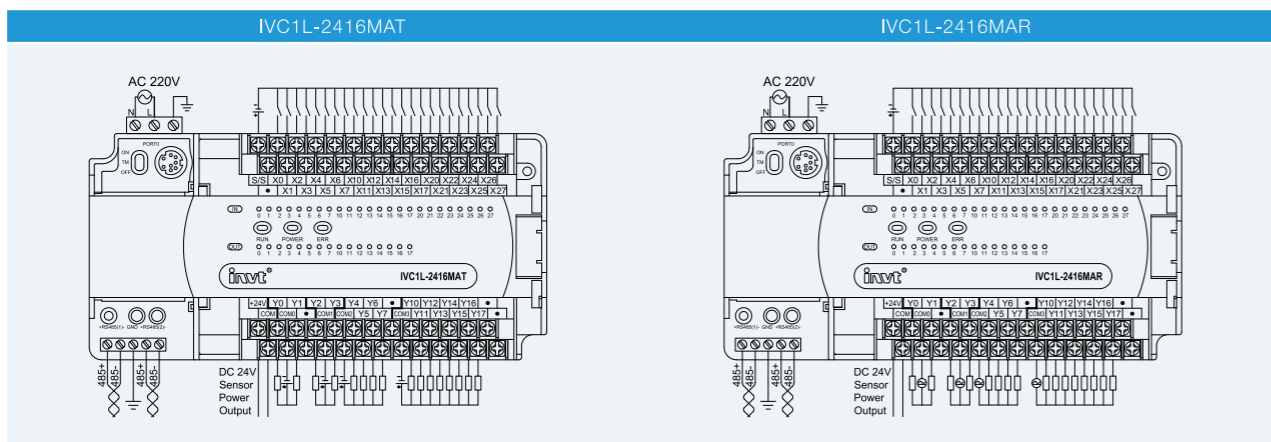
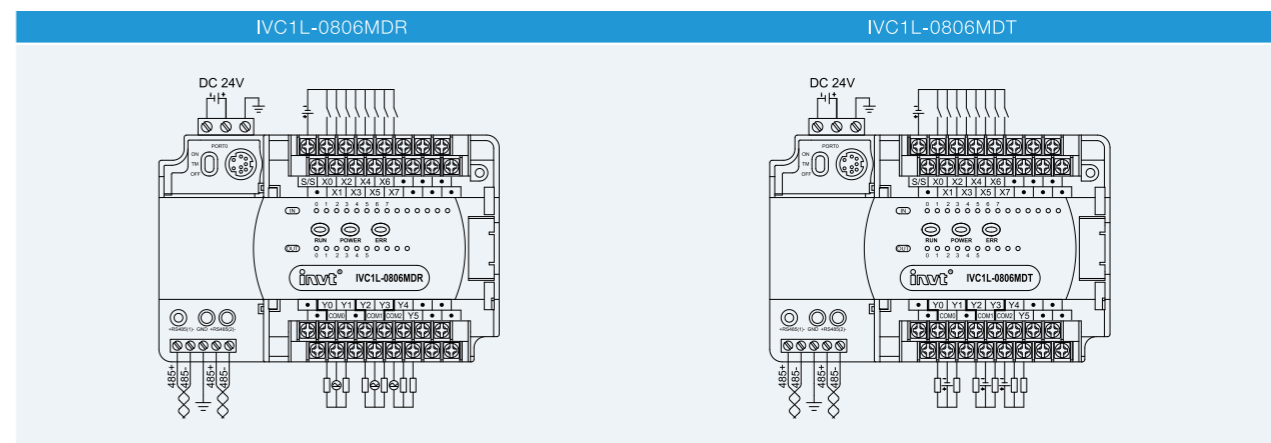

IVC1L extension module

● Digital input module

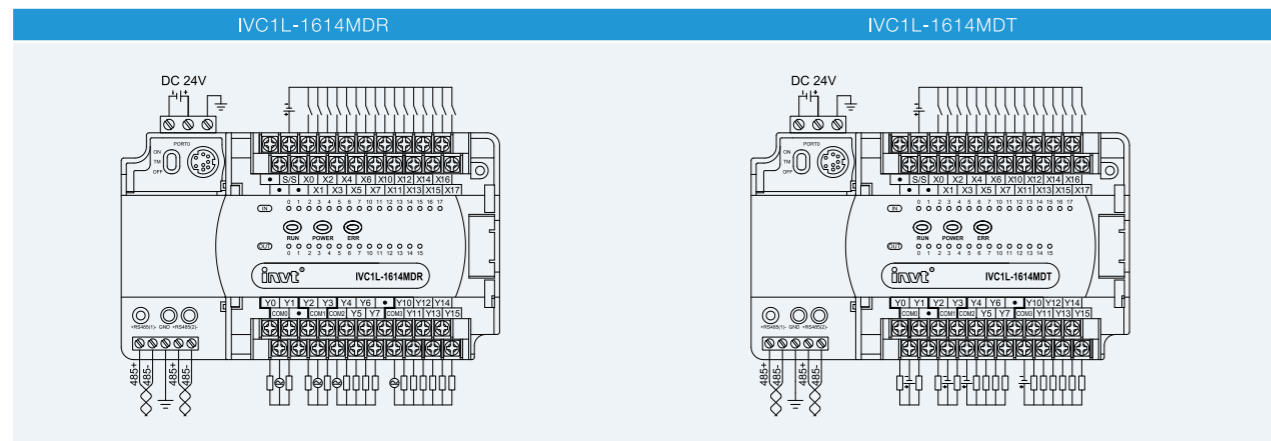

Model	IVC1L-1600ENN	
Product overview	16 digital inputs	
General		
Dimension	61×90×81.2mm	
Power	5V/GND	70mA
	24V/GND	-
Output specification		
Inputs	16	
Input type	PNP/NPN (source type/sink type)	
Input voltage	24VDC	
Current	60mA (DC24V/COM)	
Insulation	Optocoupler insulation	
Action indication	LED is on when optocoupler is driven	
Equivalent resistance	4.3kΩ/channel	
Logic 1 signal	≥15VDC	
Logic 0 signal	≤5VDC	

● Digital output module

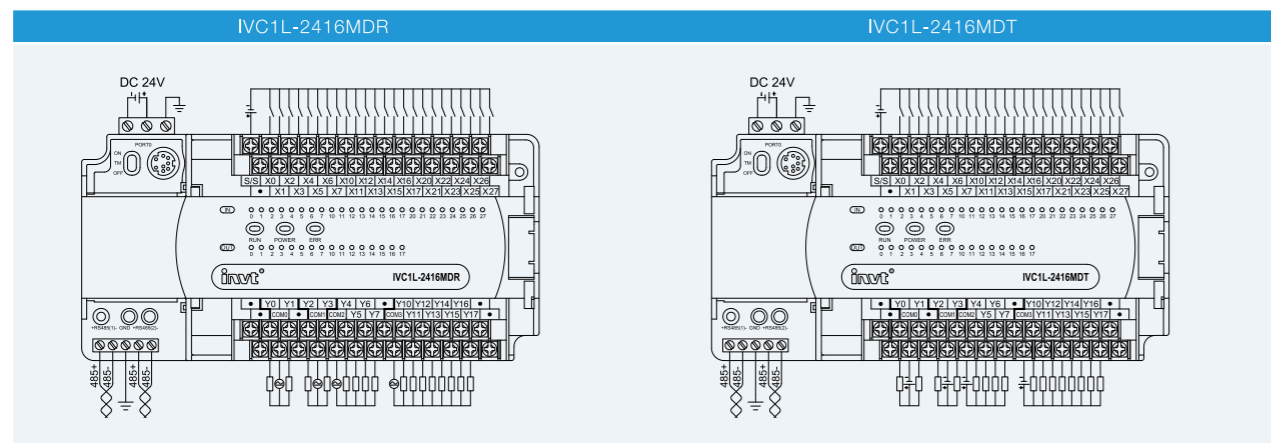

Model	IVC1L-0016ENT	
Product overview	16 points transistor output	
General		
Dimension	61×90×81.2mm	
Power	5V/GND	170mA
	24V/GND	-
Output specification		
Outputs	16	
Output type	Transistor	
Voltage	24VDC	
Insulation	Optocoupler insulation	
Action indication	LED is on when optocoupler is driven	
Minimum load	5mA (5-24VDC)	
Max. output current	Resistive load	Total current can be increased by 0.1A for every additional 1 point above 8 points
	Inductive load	24VDC, 7.2W
	Lamp load	24VDC, 1.5W
Response time	OFF→ON	Max.0.5ms (100mA/24VDC)
	ON→OFF	Max.0.5ms (100mA/24VDC)
Contact life	-	

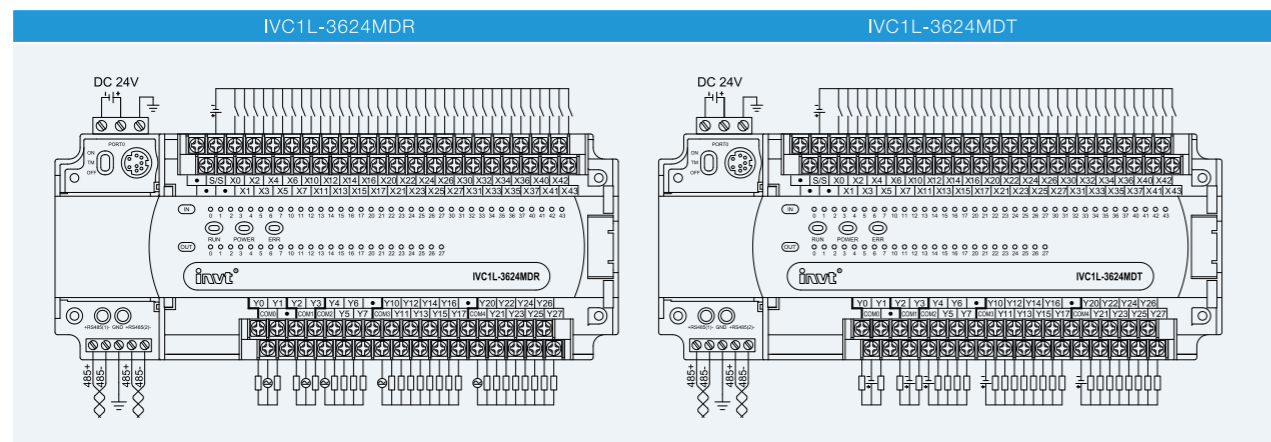

Model	IVC1L-0016ENR	
Product overview	16 points relay output	
General		
Dimension	61×90×81.2mm	
Power	5V/GND	70mA
	24V/GND	100mA
Output specification		
Outputs	16	
Output type	Relay	
Voltage	250VAC, below 30VDC	
Insulation	Mechanical insulation of relay	
Action indication	The LED light is on when relay output contact closed	
Minimum load	2mA/5VDC	
Max. output current	Resistive load	2A/1point, The total current of 8 points of common COM terminal is less than 8A
	Inductive load	220VAC, 80VA
	Lamp load	220VAC, 100W
Response time	OFF→ON	Max.20ms
	ON→OFF	Max.20ms
Contact life	200,000 time	

● Digital input/output module



Model	IVC1L-0808ENT	
Product overview	8 digital inputs, 8 points transistor output	
General		
Dimension	61×90×81.2mm	
Power	5V/GND	170mA
	24V/GND	-
Input specification		
Inputs	8	
Input type	PNP/NPN (source type/sink type)	
Input voltage	24VDC	
Current	50mA (DC24V/COM)	
Insulation	Optocoupler insulation	
Action indication	LED is on when optocoupler is driven	
Equivalent resistance	4.3kΩ/channel	
Logic 1 signal	≥15VDC	
Logic 0 signal	≤5VDC	
Output specification		
Outputs	8	
Output type	Transistor	
Voltage	5~24VDC	
Insulation	Optocoupler insulation	
Action indication	LED is on when optocoupler is driven	
Minimum load	5mA (5~24VDC)	
Max. output current	Resistive load	0.3A/1 point 0.8A/4points 1.6A/8points
	Inductive load	24VDC, 7.2W
	Lamp load	24VDC, 1.5W
Response time	OFF→ON	Max.0.5ms (100mA/24VDC)
	ON→OFF	Max.0.5ms (100mA/24VDC)
Contact life	-	



Model	IVC1L-0808ENR	
Product overview	8 digital inputs,8 points relay output	
General		
Dimension	61×90×81.2mm	
Power	5V/GND	70mA
	24V/GND	50mA
Input specification		
Inputs	8	
Input type	PNP/NPN (source type/sink type)	
Input voltage	24VDC	
Current	50mA (DC24V/COM)	
Insulation	Optocoupler insulation	
Action indication	LED is on when optocoupler is driven	
Equivalent resistance	4.3kΩ/channel	
Logic 1 signal	≥15VDC	
Logic 0 signal	≤5VDC	
Output specification		
Outputs	8	
Output type	Relay	
Voltage	250VAC, below 30VDC	
Insulation	Mechanical insulation of relay	
Action indication	The LED light is on when relay output contact closed	
Minimum load	2mA/5VDC	
Max. output current	Resistive load	2A/1point , The total current of 8 points of common COM terminal is less than 8A
	Inductive load	220VAC, 80VA
	Lamp load	220VAC, 100W
Response time	OFF→ON	Max.20ms
	ON→OFF	Max.20ms
Contact life	200,000 time	

● Analog input module



Model	IVC1L-2AD	
Product overview	2 analog inputs	
General		
Dimension	61×90×81.2mm	
Power	5V/GND	70mA
	24V/GND	-
Input specification		
Conversion speed	15ms/channel (normal speed), 6ms/channel (high speed), settable	
Range	Voltage input	-10V~+10V -5V~+5V
	Current input	-20mA~+20mA
Digital format	Default: -2000~+2000; Range: -10000~+10000	
Resolution	12 bit	
Accuracy	±1%FS	
Isolation	The optocoupler isolates analog circuit from digital circuit. The analog circuit is internally isolated from the 24VDC power supply of the module. No isolation between analog channels.	

Model	IVC1L-4AD	
Product overview	4 analog inputs	
General		
Dimension	61×90×81.2mm	
Power	5V/GND	70mA
	24V/GND	-
Input specification		
Conversion speed	15ms/channel (normal speed), 6ms/channel (high speed), settable	
Range	Voltage input	-10V~+10V -5V~+5V
	Current input	-20mA~+20mA
Digital format	Default: -2000~+2000; Range: -10000~+10000	
Resolution	12 bit	
Accuracy	±1%FS	
Isolation	The optocoupler isolates analog circuit from digital circuit. The analog circuit is internally isolated from the 24VDC power supply of the module. No isolation between analog channels.	

● Analog output module



Model	IVC1L-2DA	
Product overview	2 analog outputs	
General		
Dimension	61×90×81.2mm	
Power	5V/GND	72mA
	24V/GND	-
External power	24VDC (-15%~20%), Maximum allowable ripple voltage 5%, 100mA	
Output specification		
Conversion speed	2ms/channel	
Range	Voltage output	-10V~+10V
	Current output	0~20mA 4~20mA
Digital format	Default: -2000~+2000; Range: -10000~+10000	
Resolution	12 bit	
Accuracy	±1%FS	
Isolation	The optocoupler isolates analog circuit from digital circuit. The analog circuit is internally isolated from the 24VDC power supply of the module. No isolation between analog channels.	

Model	IVC1L-4DA	
Product overview	4 analog outputs	
General		
Dimension	61×90×81.2mm	
Power	5V/GND	72mA
	24V/GND	-
External power	24VDC (-15%~20%), Maximum allowable ripple voltage 5%, 100mA	
Output specification		
Conversion speed	2ms/channel	
Range	Voltage output	-10V~+10V
	Current output	0~20mA 4~20mA
Digital format	Default: -2000~+2000; Range: -10000~+10000	
Resolution	12 bit	
Accuracy	±1%FS	
Isolation	The optocoupler isolates analog circuit from digital circuit. The analog circuit is internally isolated from the 24VDC power supply of the module. No isolation between analog channels.	

● Analog input/output module



Model	IVC1L-5AM	
Product overview	4 analog inputs, 1 analog output	
General		
Dimension	61x90x81.2mm	
Power	5V/GND	72mA
	24V/GND	-
Input specification		
Conversion speed	15ms/channel (normal speed), 8ms/channel (high speed), settable	
Voltage input	-10V~+10V	-5V~+5V
Range	Current input	-20mA~+20mA
	Digital format	Default: -2000~+2000; Range: -10000~+10000
Resolution	12 bit	
Accuracy	±1%FS	
Isolation	The optocoupler isolates analog circuit from digital circuit. The analog circuit is internally isolated from the 24VDC power supply of the module. No isolation between analog channels.	
Output specification		
Conversion speed	2ms/channel	
Voltage output	-10V~+10V	
Range	Current output	0~20mA 4~20mA
	Digital format	Default: -2000~+2000; Range: -10000~+10000
Resolution	12 bit	
Accuracy	±1%FS	
Isolation	The optocoupler isolates analog circuit from digital circuit. The analog circuit is internally isolated from the 24VDC power supply of the module. No isolation between analog channels.	

● Thermocouple module



Model	IVC1L-4TC	
Product overview	4 thermocouple	
General		
Dimension	61x90x81.2mm	
Power	5V/GND	72mA
	24V/GND	-
External power	24VDC (-15%~20%), Maximum allowable ripple voltage5%, 50mA	
Input specification		
Conversion speed	240ms/channel	
Input type	K/J/E/N/T/R/S type thermocouple	
Digital format	Celsius (0.1 ° C)	K type: -1000~+12000 E type: -1000~+10000 T type: -2000~+4000 S type: 0~16000 J type: -1000~+10000 N type: -1000~+12000 R type: 0~16000
	Fahrenheit (0.1 ° F)	K type: -1480~+21920 E type: -1480~+18320 T type: -3280~+7520 S type: 320~29120 J type: -1480~+18320 N type: -1480~+21920 R type: 320~29120
Resolution	0.5 ° C/0.9 ° F; 12bit	
Accuracy	±0.5%FS+1 ° C	
Isolation	The optocoupler isolates analog circuit from digital circuit. The analog circuit is internally isolated from the 24VDC power supply of the module. No isolation between analog channels.	



Model	IVC1L-2TC	
Product overview	2 thermocouple	
General		
Dimension	61x90x81.2mm	
Power	5V/GND	72mA
	24V/GND	-
External power	24VDC (-15%~20%), Maximum allowable ripple voltage5%, 50mA	
Input specification		
Conversion speed	240ms/channel	
Input type	K/J/E/N/T/R/S type thermocouple	
Digital format	Celsius (0.1 ° C)	K type: -1000~+12000 E type: -1000~+10000 T type: -2000~+4000 S type: 0~16000 J type: -1000~+10000 N type: -1000~+12000 R type: 0~16000
	Fahrenheit (0.1 ° F)	K type: -1480~+21920 E type: -1480~+18320 T type: -3280~+7520 S type: 320~29120 J type: -1480~+18320 N type: -1480~+21920 R type: 320~29120
Resolution	0.5 ° C/0.9 ° F; 12bit	
Accuracy	±0.5%FS+1 ° C	
Isolation	The optocoupler isolates analog circuit from digital circuit. The analog circuit is internally isolated from the 24VDC power supply of the module. No isolation between analog channels.	

● Thermal resistance module



Model	IVC1L-2PT	
Product overview	2 thermal resistance	
General		
Dimension	61x90x81.2mm	
Power	5V/GND	72mA
	24V/GND	-
External power	24VDC (-15%~20%), Maximum allowable ripple voltage5%, 50mA	
Input specification		
Conversion speed	15ms/channel	
Input type	Pt100/Cu100/Cu50	
Digital format	Celsius (0.1 ° C)	Pt100: -1500~+6000 Cu100: -300~+1200 Cu50: -300~+1200
	Fahrenheit (0.1 ° F)	Pt100: -2380~+11120 Cu100: -220~+2480 Cu50: -220~+2480
Resolution	0.2 ° C/0.36 ° F; 12bit	
Accuracy	±1%FS	
Isolation	The optocoupler isolates analog circuit from digital circuit. The analog circuit is internally isolated from the 24VDC power supply of the module. No isolation between analog channels.	



Model	IVC1L-4PT	
Product overview	4 thermal resistance	
General		
Dimension	61x90x81.2mm	
Power	5V/GND	72mA
	24V/GND	-
External power	24VDC (-15%~20%), Maximum allowable ripple voltage5%, 50mA	
Input specification		
Conversion speed	15ms/channel	
Input type	Pt100/Cu100/Cu50	
Digital format	Celsius (0.1 ° C)	Pt100: -1500~+6000 Cu100: -300~+1200 Cu50: -300~+1200
	Fahrenheit (0.1 ° F)	Pt100: -2380~+11120 Cu100: -220~+2480 Cu50: -220~+2480
Resolution	0.2 ° C/0.36 ° F; 12bit	
Accuracy	±1%FS	
Isolation	The optocoupler isolates analog circuit from digital circuit. The analog circuit is internally isolated from the 24VDC power supply of the module. No isolation between analog channels.	

IVC1L extension module dimension

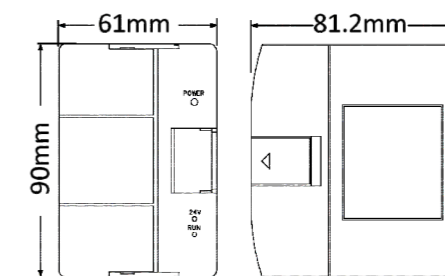

Model	Dimension
IVC1L extension module	61x90x81.2mm

IVC1L extension module wiring diagram

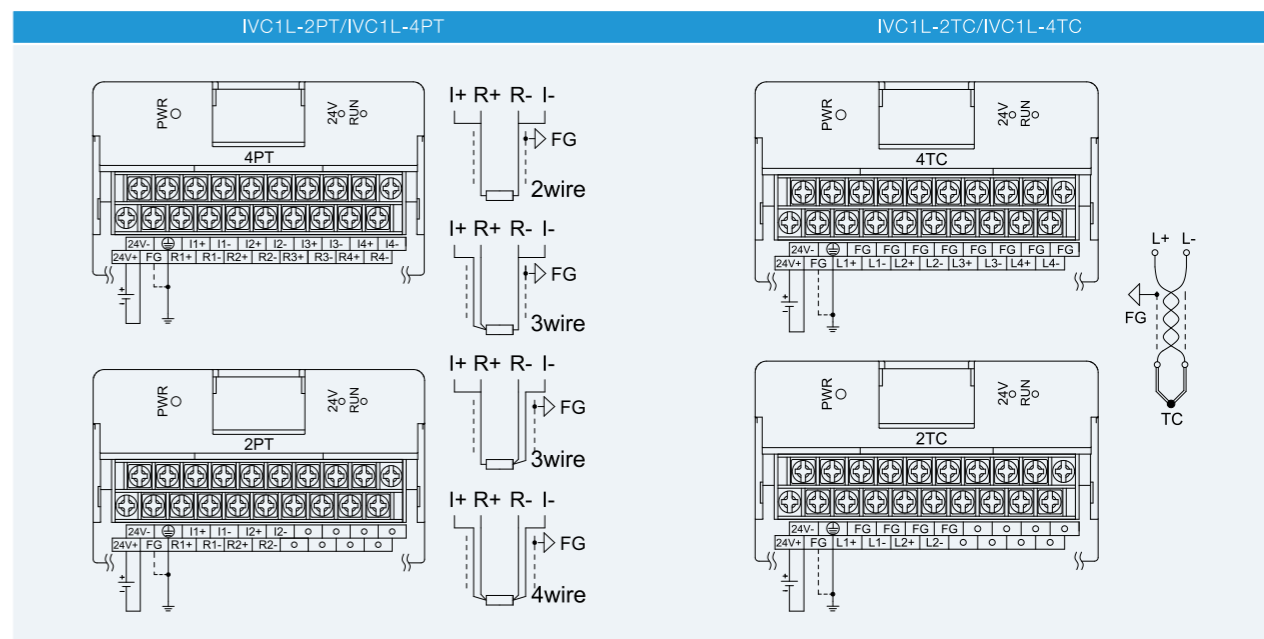
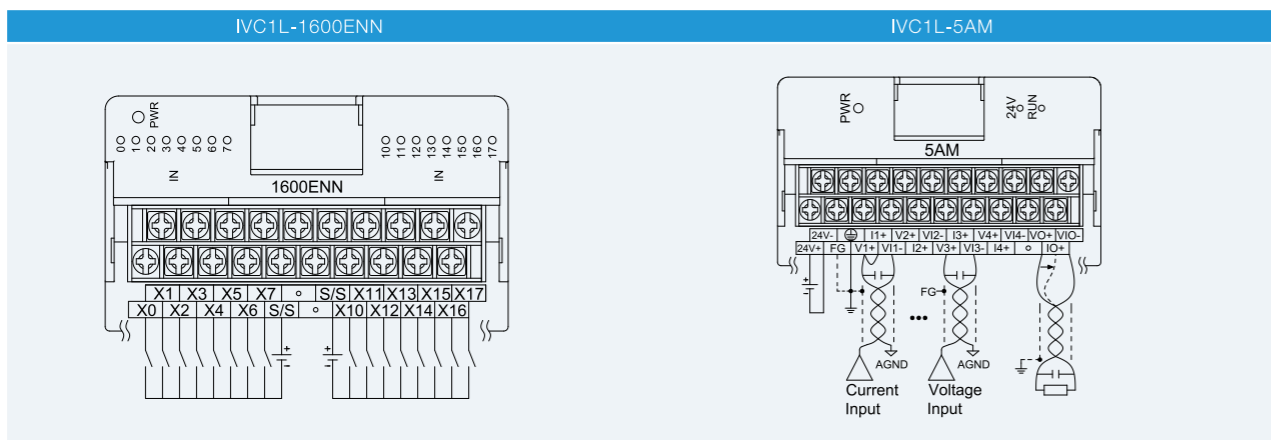
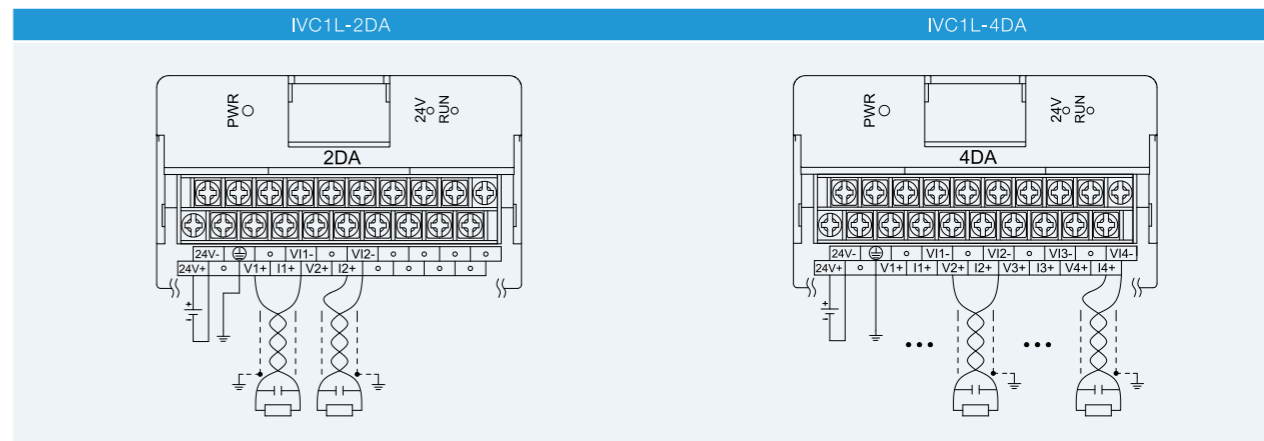
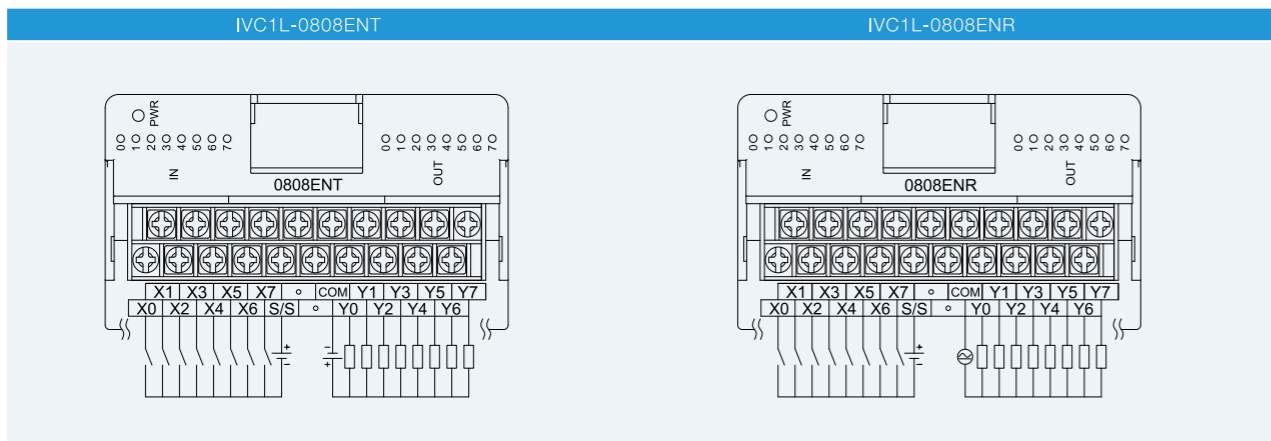
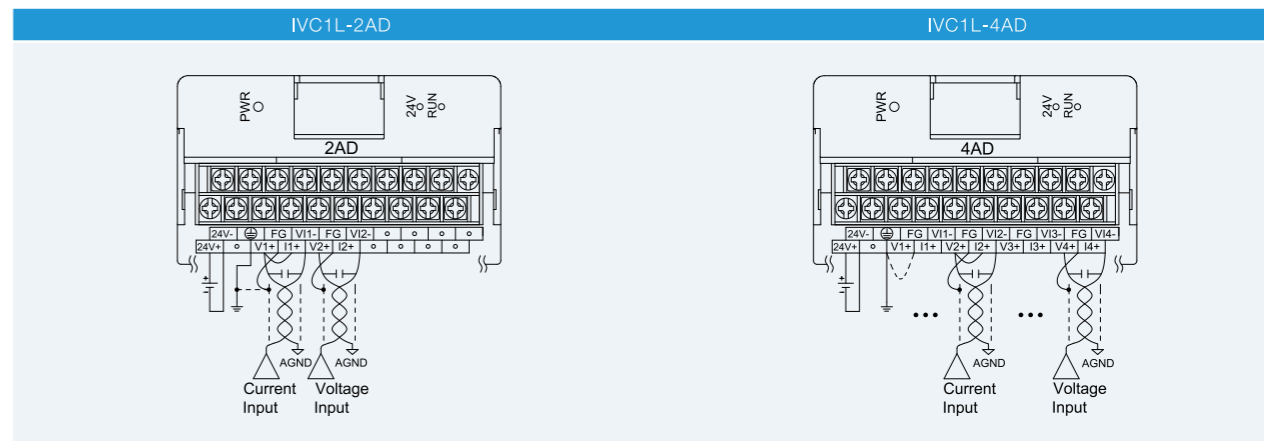
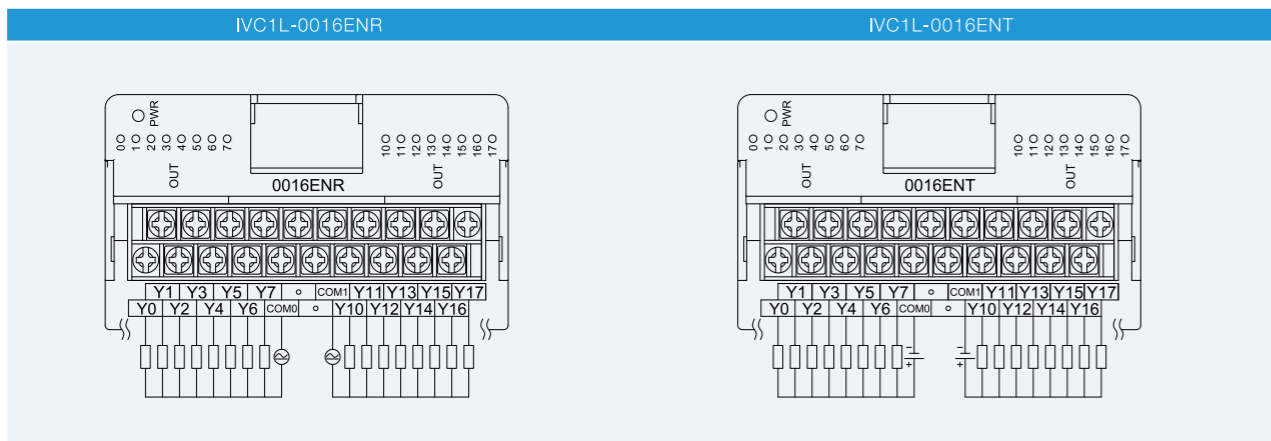

IVC2 feature

The new hardware architecture of IVC2 supports Ethernet Modbus-TCP master/slave communication, suitable for medium-complexity motion control occasions such as multi-pulse axes and CANOpen bus axes.

- Built-in maximum 64 I/O, support 8 extension modules and 256 expanding I/O
- 32K step program capacity
- 1 RS232, 2 RS485, support MODBUS master/slave
- 6 high speed input (4×10K, 2×100K)
- Support CANOpenDS301 protocol, and maximum 16 slaves
- Support Ethernet (MODBUS-TCP) communication
- Support upload/download program via USB

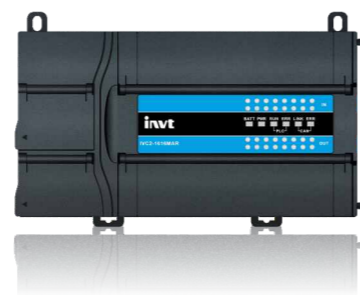

IVC2 technical specification

Model	IVC2-	1616MAR	3232MAR
Power supply			
Input	Voltage	220VAC (85~264VAC)	
	Current	1.5A	
Output	5V/GND	1000mA	
	24V/GND	650mA	
	24V/COM	600mA	
I/O configuration			
Built-in I/O	Total	32	64
	Inputs	16	32
	Outputs	16	32
	Input type	NPN/PNP	
Extension I/O	Output type	Relay	
	Extension module	8	
	Total	256	
High speed I/O			
High speed input	2×100KHz + 4×10KHz, 1×100KHz (AB phase), 2×10KHz		
High speed output	-		
Communication			
Serial port	RS232	1	
	RS485	2, built-in terminal resistance	
	Protocol	programming protocol; MODBUS master/slave; free port; N: N protocol	
Ethernet	Interface	Ethernet, self-adaption	
	Protocol	Programming protocol; MODBUS-TCP Master/slave protocol	
CANopen	Protocol	Protocol, support master/slave station	
	Master	As a master, support up to 16 slaves, support 64 TxPDO and 64 RxPDO	
	Slave	As a slave, support 4 TxPDO and 4 RxPDO	
USB	USB2.0; Mini-USB interface, support program upload/download, monitor and firmware update		
Storage			
Program capacity	32K step		
Data block	8000 D registers		
Interrupt			
External input interrupt	16		
High speed counter interrupt	6		
Internal time interrupt	3		
Serial port interrupt	12		
PTO output completion interrupt	-		
Power loss interrupt	1		
Programming			
Software	Auto Station		
Subprogram calling	Supported total 64 subprograms (6 levels), and it can supports the design of input and output interfaces		
Others			
Digital filtering function	X0~X5 adopts digital filtering and other ports adopt hardware filtering		
Encryption	Upload/download password, monitor password, subprogram encryption, format disable, upload disable		
Real time clock	Support, backup battery for 3 years		
Data saving function at power failure	Support, backup battery for 3 years		

Model	IVC2-	1616MAR	3232MAR
Soft element			
Inputs			X element, 256
Outputs			Y element, 256
Auxiliary relays			M element, 2048
Local auxiliary relays			Lm element, 64
Special auxiliary relays			Sm element, 1024
Status relays			S element, 1024
Data registers			D element, 8000
Local data registers			V element, 64
Indexing/addressing registers			Z element, 16
Special data registers			Sd element, 1024
Timer	Total		T element, 256
	1ms		T252~T255
	10ms		T210~T251
	100ms		T0~T209
Counter	Total		C element, 256
	16bit up counter		C0~C199
	32bit up/down counter		C200~C235
	32bit high speed counter		C236~C255
Rising edge			1024
Falling edge			1024

IVC2 dimension

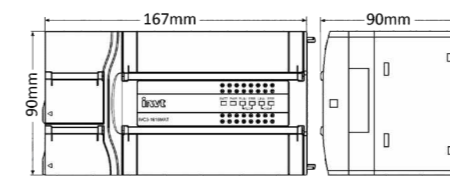

Model	Dimension
IVC2-1616M**	167×90×90mm

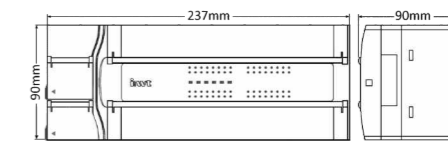

Model	Dimension
IVC2-3232M**	237×90×90mm

IVC2 wiring diagram

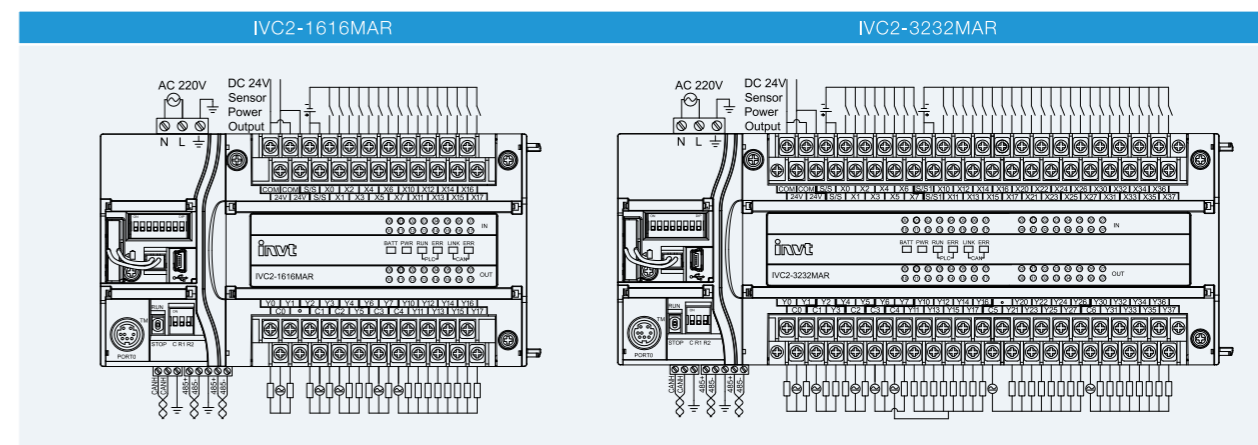

IVC3 feature

The new hardware architecture of IVC3 supports electronic cam and Ethernet MODBUS-TCP master-slave communication, suitable for multi-axis high-speed motion control and special application process applications.

- Built-in maximum 64 I/O, support 8 extension modules and 256 expanding I/O
- 64K step program capacity
- 1 RS232, 2 RS485, support MODBUS master/slave protocol
- 8 200K high speed input
- 8 200K high speed output (transistor type)
- Support CANOpenDS301 protocol, and maximum 32 slaves
- Support Ethernet (MODBUS-TCP) communication
- Support program upload/download via USB



IVC3 technical specification

Model	IVC3-	1616MAT	1616MAT-4	1616MAT-M	3232MAT	3232MAT-4	3232MAT-M	
Power supply								
Input	Voltage	220VAC (85~264VAC)						
	Current	1.5A						
Output	5V/GND	1000mA						
	24V/GND	650mA						
	24V/COM	600mA						
I/O configuration								
Built-in I/O	Total	32	32	32	64	64	64	
	Inputs	16	16	16	32	32	32	
	Outputs	16	16	16	32	32	32	
	Input type	NPN/PNP						
	Output type	Transistor (NPN)						
Extension I/O	Extension module	8						
	Total	256						
High speed I/O								
High speed input	8x200KHz, 4x200KHz (AB phase)							
High speed output	8x200KHz	4x200KHz	5x200KHz	8x200KHz	4x200KHz	5x200KHz		
electronic cam	-	-	Support	-	-	Support		
electronic gear	-	-	Support	-	-	Support		
Communication								
Serial port	RS232	1						
	RS485	2, built-in terminal resistance						
	Protocol	Programming protocol; MODBUS master/slave protocol; free port; N:N protocol						
Ethernet	Interface	Ethernet, self-adaption						
	Protocol	Programming protocol; MODBUS-TCP Master/slave protocol						
CANopen	Protocol	protocol, support master/slave station						
	Master	As a master, support up to 16 slaves, support 64 TxPDO and 64 RxPDO						
	Slave	As a slave, support 4TxPDO and 4 RxPDO						
USB	USB2.0; Mini-USB interface, support program upload/download, monitor and firmware update							
Storage								
Program capacity	64K step							
Data block	8000 D registers, 32768 R registers							
Interrupt								
External input interrupt	16							
High speed counter interrupt	8							
Internal time interrupt	12							
Serial port interrupt	8							
PTO output completion interrupt	1							
Power loss interrupt	8							
Programming								
Software	Auto Station							
Subprogram calling	Supported total 64 subprograms (6 levels), and it can supports the design of input and output interfaces							
Others								
Digital filtering function	X0~X7 adopts digital filtering and other ports adopt hardware filtering							
Encryption	Upload/download password, monitor password, subprogram encryption, format disable, upload disable							
Real time clock	Support, backup battery for 3 years							
Data saving function at power failure	Support, backup battery for 3 years							

Model	IVC3-	1616MAT	1616MAT-4	1616MAT-M	3232MAT	3232MAT-4	3232MAT-M
Soft element							
Inputs	X element, 512						
Outputs	Y element, 512						
Auxiliary relays	M element, 10240						
Local auxiliary relays	LM element, 64						
Special auxiliary relays	SM element, 1024						
Status relays	S element, 4096						
Data registers	D element, 8000; R element, 32768						
Local data registers	V element, 64						
Indexing/addressing registers	Z element, 16						
Special data registers	SD element, 1024						
Timer	Total	T element, 512					
	1ms	T480~T511					
	10ms	T210~T479					
	100ms	T0~T209					
Counter	Total	C element, 307					
	16bit up counter	C0~C199					
	32bit up/down counter	C200~C235					
	32bit high speed counter	C236~C255, C301~C307, C256~C300					
Rising edge	1024						
Falling edge	1024						

IVC3 dimension

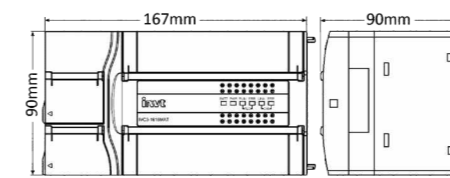

Model	Dimension
IVC3-1616M**	167x90x90mm

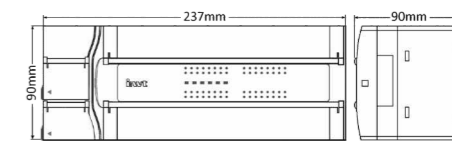

Model	Dimension
IVC3-3232M**	237x90x90mm

IVC3 wiring diagram

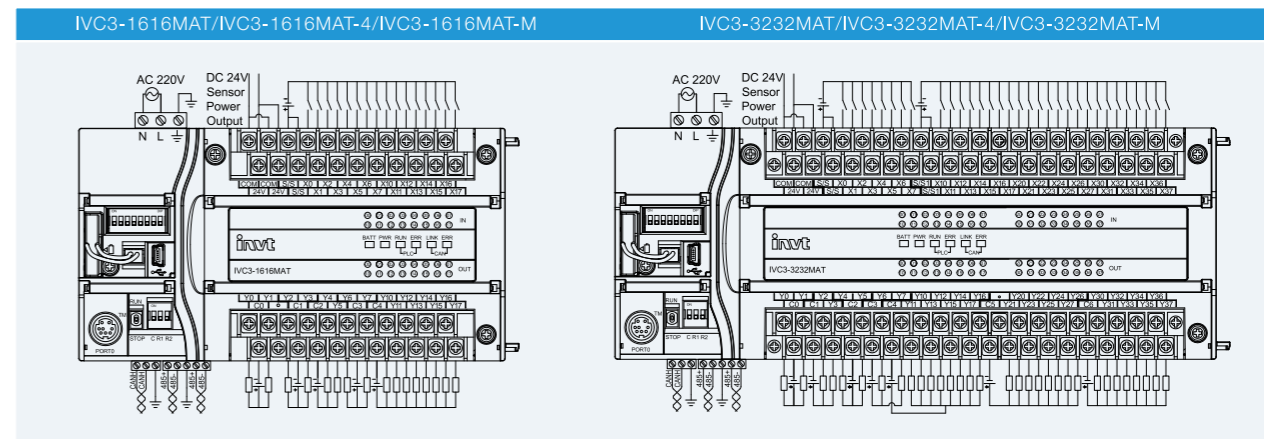

IVC-EH module specification

● Digital input module



Model	IVC-EH-1600ENN	
Product overview	16 digital inputs	
General		
Dimension	65×90×90mm	
Power	5V/GND	120mA
	24V/GND	—
Input specification		
Inputs	16	
Input type	PNP/NPN (source type/sink type)	
Input voltage	24VDC	
Current	90mA (DC24V/COM)	
Insulation	Optocoupler insulation	
Action indication	LED is on when optocoupler is driven	
Equivalent resistance	5kΩ/channel	
Logic 1 signal	≥15VDC	
Logic 0 signal	≤5VDC	

● Digital input module



Model	IVC-EH-0016ENT	
Product overview	16 points transistor output	
General		
Dimension	65×90×90mm	
Power	5V/GND	200mA
	24V/GND	—
Output specification		
Outputs	16	
Output type	Transistor	
Voltage	24VDC	
Insulation	Optocoupler insulation	
Action indication	LED is on when optocoupler is driven	
Minimum load	5mA (5~24VDC)	
Max. output current	Resistive load	0.3A/1 point, 0.8A/4points, 1.6A/8points, 2.0A/16points
	Inductive load	24VDC, 7.2W
	Lamp load	24VDC, 1.5W
Response time	OFF→ON	Max. 0.5ms (100mA/24VDC)
	ON→OFF	Max. 0.5ms (100mA/24VDC)
Contact life	—	



Model	IVC-EH-0016ENR	
Product overview	16 points relay output	
General		
Dimension	65×90×90mm	
Power	5V/GND	120mA
	24V/GND	100mA
Output specification		
Outputs	16	
Output type	Relay	
Voltage	250VAC, below 30VDC	
Insulation	Mechanical insulation of relay	
Action indication	The LED light is on when relay output contact closed	
Minimum load	2mA/5VDC	
Max. output current	Resistive load	2A/1point, The total current of 8 points of common COM terminal is less than 8A
	Inductive load	220VAC, 80VA
	Lamp load	220VAC, 100W
Response time	OFF→ON	Max. 20ms
	ON→OFF	Max. 20ms
Contact life	200,000 times	

● Digital input/output module



Model	IVC-EH-0808ENT	
Product overview	8 points digital input, 8 points transistor output	
General		
Dimension	65×90×90mm	
Power	5V/GND	150mA
	24V/GND	—
Input specification		
Inputs	8	
Input type	PNP/NPN (source type/sink type)	
Input voltage	24VDC	
Current	45mA (DC24V/COM)	
Insulation	Optocoupler insulation	
Action indication	LED is on when optocoupler is driven	
Equivalent resistance	5kΩ/channel	
Logic 1 signal	≥15VDC	
Logic 0 signal	≤5VDC	
Output specification		
Outputs	8	
Output type	Transistor	
Voltage	24VDC	
Insulation	Optocoupler insulation	
Action indication	LED is on when optocoupler is driven	
Minimum load	5mA (5~24VDC)	
Max. output current	Resistive load	0.3A/1 point, 0.8A/4points, 1.6A/8points
	Inductive load	24VDC, 7.2W
	Lamp load	24VDC, 1.5W
Response time	OFF→ON	Max. 0.5ms (100mA/24VDC)
	ON→OFF	Max. 0.5ms (100mA/24VDC)
Contact life	—	



Model	IVC-EH-0808ENR	
Product overview	8 points digital input, 8 points relay output	
General		
Dimension	65×90×90mm	
Power	5V/GND	120mA
	24V/GND	50mA
Input specification		
Inputs	8	
Input type	PNP/NPN (source type/sink type)	
Input voltage	24VDC	
Current	45mA (DC24V/COM)	
Insulation	Optocoupler insulation	
Action indication	LED is on when optocoupler is driven	
Equivalent resistance	5kΩ/channe	
Logic 1 signal	≥15VDC	
Logic 0 signal	≤5VDC	
Output specification		
Outputs	8	
Output type	Relay	
Voltage	250VAC, below 30VDC	
Insulation	Mechanical insulation of relay	
Action indication	The LED light is on when relay output contact closed	
Minimum load	2mA/5VDC	
Max. output current	Resistive load	2A/1point, The total current of 8 points of common COM terminal is less than 8A
	Inductive load	220VAC, 80VA
	Lamp load	220VAC, 100W
Response time	OFF→ON	Max. 20ms
	ON→OFF	Max. 20ms
Contact life	200,000 times	

● Digital input/output module



Model	IVC-EH-1616ENT	
Product overview	16 points digital input, 16 points transistor output	
General		
Dimension	65x90x90mm	
Power	5V/GND	150mA
	24V/GND	-
External power	24VDC (-15%~20%), Max. allowable ripple voltage5%, 50mA	
Input specification		
Inputs	16	
Input type	PNP/NPN(source type/sink type)	
Input voltage	24VDC	
Current	45mA (DC24V/COM)	
Insulation	Optocoupler insulation	
Action indication	LED is on when optocoupler is driven	
Equivalent resistance	5kΩ/channel	
Logic 1 signal	≥15VDC	
Logic 0 signal	≤5VDC	
Output specification		
Outputs	16	
Output type	Transistor	
Voltage	24VDC	
Insulation	Optocoupler insulation	
Action indication	LED is on when optocoupler is driven	
Minimum load	5mA (5~24VDC)	
Max. output current	Resistive load	0.3A/1 point, 0.8A/4points, 1.6A/8points, 2.0A/16points
	Inductive load	24VDC, 7.2W
	Lamp load	24VDC, 1.5W
Response time	OFF→ON	Max. 0.5ms (100mA/24VDC)
	ON→OFF	Max. 0.5ms (100mA/24VDC)
Contact life	-	

● Analog input module



Model	IVC-EH-4AD	
Product overview	4 analog inputs	
General		
Dimension	65x90x90mm	
Power	5V/GND	72mA
	24V/GND	-
External power	24VDC (-15%~20%), Max. allowable ripple voltage5%, 50mA	
Input specification		
Coverion speed	4ms/channel	
Range	Voltage input	-10V~+10V -5V~+5V 1V~5V
	Current input	-20mA~+20mA 4mA~20mA
	Digital format	Default: -10000~+10000; can be set by software
Resolution	16 bit	
Accuracy	±1%FS	
Isolation	The optocoupler isolates analog circuit from digital circuit. The analog circuit is internally isolated from the 24VDC power supply of the module. No isolation between analog channels.	

● Analog output module



Model	IVC-EH-4DA	
Product overview	4 analog outputs	
General		
Dimension	65x90x90mm	
Power	5V/GND	72mA
	24V/GND	/
External power	24VDC (-15%~20%), Max. allowable ripple voltage5%,50mA	
Output specification		
Coverion speed	2ms/channel	
Range	Voltage output	-10V~+10V
	Current output	0~20mA 4~20mA
	Digital format	Default: -10000~+10000; Range: -10000~+10000
Resolution	16 bit	
Accuracy	±0.5%FS	
Isolation	The optocoupler isolates analog circuit from digital circuit. The analog circuit is internally isolated from the 24VDC power supply of the module. No isolation between analog channels.	

● Thermocouple module



Model	IVC-EH-4TC	
Product overview	4 thermocouple	
General		
Dimension	65x90x90mm	
Power	5V/GND	72mA
	24V/GND	-
External power	24VDC (-15%~20%), Max. allowable ripple voltage5%, 50mA	
Input specification		
Coverion speed	240ms/channel	
Input type	K/J/E/N/T/R/S type thermocouple	
Digital format	Celsius (0.1 ° C)	K type: -1000~+12000 J type: -1000~+10000 E type: -1000~+10000 N type: -1000~+12000 T type: -2000~+4000 R type: 0~16000 S type: 0~16000
	Fahrenheit (0.1 ° F)	K type: -1480~+21920 J type: -1480~+18320 E type: -1480~+18320 N type: -1480~+21920 T type: -3280~+7520 R type: 320~29120 S type: 320~29120
Resolution	0.5 ° C/0.9 ° F; 12bit	
Accuracy	±0.5%FS+1 ° C	
Isolation	The optocoupler isolates analog circuit from digital circuit. The analog circuit is internally isolated from the 24VDC power supply of the module. No isolation between analog channels.	

● Termal resistance module



Model	IVC-EH-4PT	
Product overview	4 thermal resistance	
General		
Dimension	65x90x90mm	
Power	5V/GND	72mA
	24V/GND	-
External power	24VDC (-15%~20%), Max. allowable ripple voltage5%, 50mA	
Input specification		
Coverion speed	240ms/channel	
Input type	Pt100/Cu100/Cu50	
Connection	2-wirings, 3-wirings, 4wirings	
Digital format	Celsius (0.1 ° C)	Pt100: -1500~+6000 Cu100: -300~+1200 Cu50: -300~+1200
	Fahrenheit (0.1 ° F)	Pt100: -2380~+11120 Cu100: -220~+2480 Cu50: -220~+2480
Resolution	0.1 ° C/0.18 ° F; 16 bit	
Accuracy	±0.5%FS	
Isolation	The optocoupler isolates analog circuit from digital circuit. The analog circuit is internally isolated from the 24VDC power supply of the module. No isolation between analog channels.	

● Power supply module



Model	IVC-EH-PWR	
Product overview	Power supply module	
General		
Dimension	65x90x90mm	
Input	Voltage	240VAC, (100~240VAC)
	Current	0.3A
Output	5V/GND	600mA
	24V/GND	500mA
Action indication	The PWR LED is on when the power supply is connected correctly	

IVC-EH module dimension

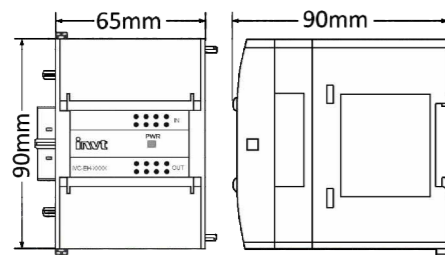

Model	Dimension
IVC-EH module	65x90x90mm

IVC-EH module wiring diagram

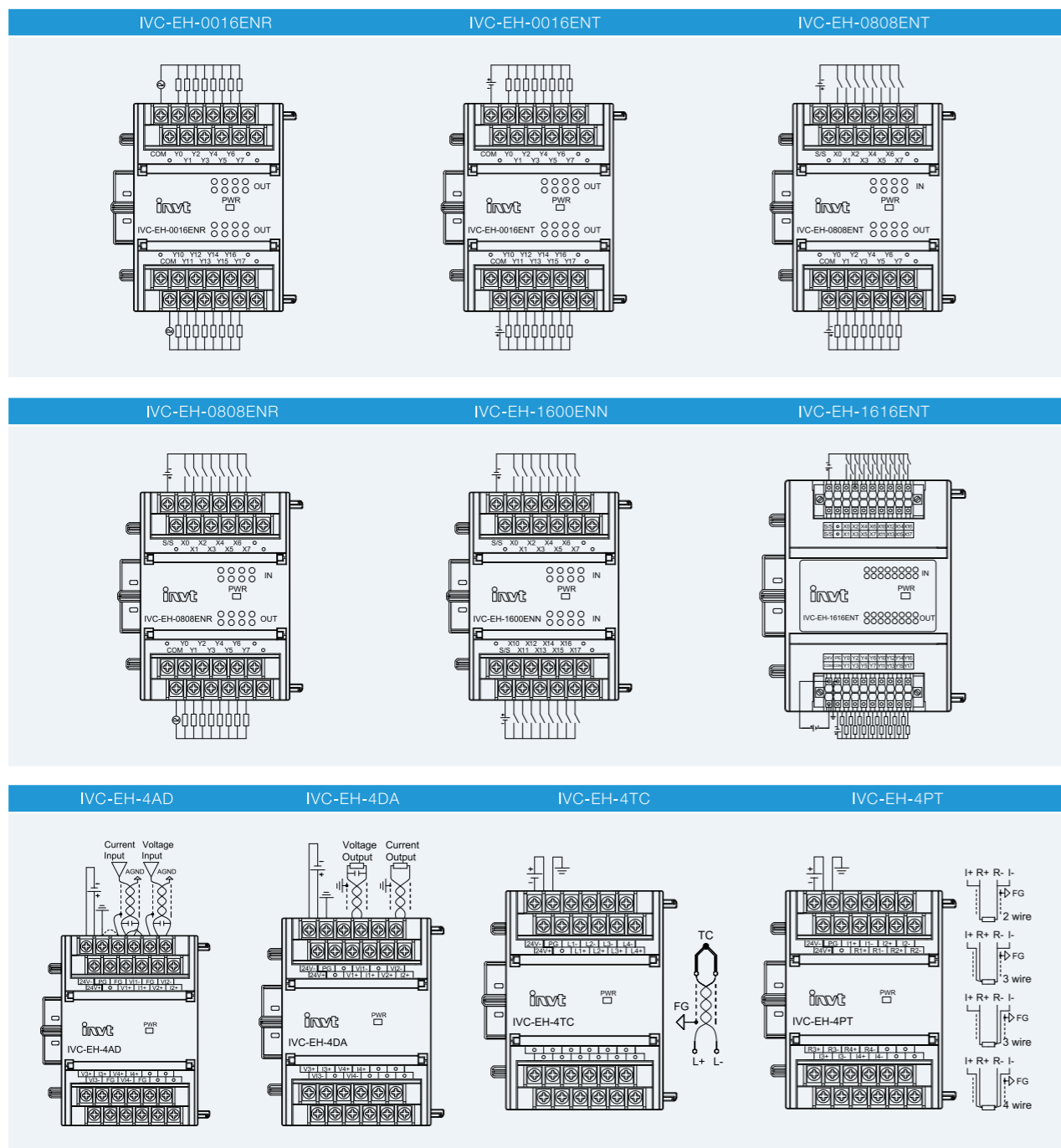

IVC PLC spare part

Product type	Description	Photo
IVC-SL1	PLC-VS HMI 232 communication cable(2m)	
IVC-SL2	PLC download cable, USB-RS232(Port0)(2m)	
IVC-SL3	PLC-VT/VK/VA HMI 232 communication cable(3m)	
IVC-SL4	HMI download cable, available for VT/VK/VA/VS series(2m)	
Product type	Description	Photo
IVC-SL5	PLC-VT/VK/VA HMI 232 communication cable(7m)	
IVC-SL8	PLC-VS HMI 232 communication cable(7m)	
IVC-SL9	IVC1L extension cable(1m)	

IVC PLC product list

● IVC1S main module ●			
Material code	Model	Description	Dimension
11060-00127	IVC1S-1006MAR	10 digital inputs, 6 relay outputs, AC220V power supply	135x90x81.2mm
11060-00126	IVC1S-1006MAT	10 digital inputs, 6 transistor outputs, AC220V power supply	135x90x81.2mm
11060-00125	IVC1S-1410MAR	14 digital inputs, 10 relay outputs, AC220V power supply	135x90x81.2mm
11060-00124	IVC1S-1410MAT	14 digital inputs, 10 transistor outputs, AC220V power supply	135x90x81.2mm
11060-00123	IVC1S-1614MAR	16 digital inputs, 14 relay outputs, AC220V power supply	150x90x81.2mm
11060-00122	IVC1S-1614MAT	16 digital inputs, 14 transistor outputs, AC220V power supply	150x90x81.2mm
11060-00121	IVC1S-2416MAR	24 digital inputs, 16 relay outputs, AC220V power supply	182x90x81.2mm
11060-00202	IVC1S-2416MAT	24 digital inputs, 16 transistor outputs, AC220V power supply	182x90x81.2mm
11060-00120	IVC1S-3624MAR	36 digital inputs, 24 relay outputs, AC220V power supply	224.5x90x81.2mm
11060-00203	IVC1S-3624MAT	36 digital inputs, 24 transistor outputs, AC220V power supply	224.5x90x81.2mm
● IVC1L main module ●			
Material code	Model	Description	Dimension
11060-00076	IVC1L-0806MAR	8 digital inputs, 6 relay outputs, AC220V power supply	135x90x81.2mm
11060-00077	IVC1L-0806MAT	8 digital inputs, 6 transistor outputs, AC220V power supply	135x90x81.2mm
11060-00070	IVC1L-1410MAR	14 digital inputs, 10 relay outputs, AC220V power supply	135x90x81.2mm
11060-00071	IVC1L-1410MAT	14 digital inputs, 10 transistor outputs, AC220V power supply	135x90x81.2mm
11060-00068	IVC1L-1614MAR	16 digital inputs, 14 relay outputs, AC220V power supply	150x90x81.2mm
11060-00069	IVC1L-1614MAT	16 digital inputs, 14 transistor outputs, AC220V power supply	150x90x81.2mm
11060-00066	IVC1L-1614MAR1	16 digital inputs, 14 relay outputs, integrated 2AI and 1AO, AC220V power supply	182x90x81.2mm
11060-00067	IVC1L-1614MAT1	16 digital inputs, 14 transistor outputs, integrated 2AI and 1AO, AC220V power supply	182x90x81.2mm
11060-00064	IVC1L-2416MAR	24 digital inputs, 16 relay outputs, AC220V power supply	182x90x81.2mm
11060-00065	IVC1L-2416MAT	24 digital inputs, 16 transistor outputs, AC220V power supply	182x90x81.2mm
11060-00062	IVC1L-3624MAR	36 digital inputs, 24 relay outputs, AC220V power supply	224.5x90x81.2mm
11060-00063	IVC1L-3624MAT	36 digital inputs, 24 transistor outputs, AC220V power supply	224.5x90x81.2mm
11060-00198	IVC1L-1616MAR6	24 digital inputs, 16 relay outputs, integrated 2 thermal resistor (PT), AC220V power supply	182x90x81.2mm
Material code	Model	Description	Dimension
11060-00139	IVC1L-0806MDR	8 digital inputs, 6 relay outputs, DC24V power supply	135x90x81.2mm
11060-00138	IVC1L-0806MDT	8 digital inputs, 6 transistor outputs, DC24V power supply	135x90x81.2mm
11060-00143	IVC1L-1410MDR	14 digital inputs, 10 relay outputs, DC24V power supply	135x90x81.2mm
11060-00142	IVC1L-1410MDT	14 digital inputs, 10 transistor outputs, DC24V power supply	135x90x81.2mm
11060-00145	IVC1L-1614MDR	16 digital inputs, 14 relay outputs, DC24V power supply	150x90x81.2mm
11060-00144	IVC1L-1614MDT	16 digital inputs, 14 transistor outputs, DC24V power supply	150x90x81.2mm
11060-00147	IVC1L-2416MDR	24 digital inputs, 16 relay outputs, DC24V power supply	182x90x81.2mm
11060-00146	IVC1L-2416MDT	24 digital inputs, 16 transistor outputs, DC24V power supply	182x90x81.2mm
11060-00149	IVC1L-3624MDR	36 digital inputs, 24 relay outputs, DC24V power supply	224.5x90x81.2mm
11060-00148	IVC1L-3624MDT	36 digital inputs, 24 transistor outputs, DC24V power supply	224.5x90x81.2mm

● IVC1L extension module ●

Material code	Model	Description	Dimension
11060-00207	IVC1L-0808ENR	8 digital inputs, 8 relay outputs	61×90×81.2mm
11060-00204	IVC1L-0808ENT	8 digital inputs, 8 transistor outputs	61×90×81.2mm
11060-00205	IVC1L-1600ENN	16 digital inputs	61×90×81.2mm
11060-00217	IVC1L-0016ENT	16 transistor outputs	61×90×81.2mm
11060-00206	IVC1L-0016ENR	16 relay outputs	61×90×81.2mm
11060-00214	IVC1L-2AD	2 analog input	61×90×81.2mm
11060-00212	IVC1L-2DA	2 analog outputs	61×90×81.2mm
11060-00215	IVC1L-2TC	2 thermocouple	61×90×81.2mm
11060-00216	IVC1L-2PT	2 thermal resistance	61×90×81.2mm
11060-00209	IVC1L-4AD	4 analog inputs	61×90×81.2mm
11060-00208	IVC1L-4DA	4 analog outputs	61×90×81.2mm
11060-00210	IVC1L-4TC	4 thermocouple	61×90×81.2mm
11060-00213	IVC1L-4PT	4 thermal resistance	61×90×81.2mm
11060-00211	IVC1L-5AM	4 analog inputs, 1 analog output	61×90×81.2mm

● IVC2 main module ●

Material code	Model	Description	Dimension
11060-00257	IVC2-1616MAR	16 digital inputs, 16 relay outputs, AC220V power supply	167×90×90mm
11060-00255	IVC2-3232MAR	32 digital inputs, 32 relay outputs, AC220V power supply	237×90×90mm

● IVC3 main module ●

Material code	Model	Description	Dimension
11060-00179	IVC3-1616MAT	16 digital input, 16 transistor output, 8x200k high speed pulse output, AC 220V power supply	167×90×90mm
11060-00244	IVC3-3232MAT	32 digital input, 32 transistor output, 8x200k high speed pulse output, AC 220V power supply	237×90×90mm
11060-00259	IVC3-1616MAT-4	16 digital input, 16 transistor output, 4x200k high speed pulse output, AC 220V power supply	167×90×90mm
11060-00261	IVC3-3232MAT-4	32 digital input, 32 transistor output, 4x200k high speed pulse output, AC 220V power supply	237×90×90mm
11060-00254	IVC3-1616MAT-M	16 digital input, 16 transistor output, 5x200k high speed pulse output, AC 220V power supply, with E-cam function	167×90×90mm
11060-00253	IVC3-3232MAT-M	32 digital input, 32 transistor output, 5x200k high speed pulse output, AC 220V power supply, with E-cam function	237×90×90mm

● IVC-EH extension module ●

Material code	Model	Description	Dimension
11060-00221	IVC-EH-0808ENR	8 digital inputs, 8 relay outputs	65×90×90mm
11060-00220	IVC-EH-0808ENT	8 digital inputs, 8 transistor outputs	65×90×90mm
11060-00218	IVC-EH-1600ENN	16 digital inputs	65×90×90mm
11060-00219	IVC-EH-0016ENR	16 relay outputs	65×90×90mm
11060-00222	IVC-EH-0016ENT	16 transistor outputs	65×90×90mm
11060-00267	IVC-EH-1616ENT	16 digital inputs, 16 transistor outputs	65×90×90mm
11060-00224	IVC-EH-4AD	4 analog inputs	65×90×90mm
11060-00223	IVC-EH-4DA	4 analog outputs	65×90×90mm
11060-00225	IVC-EH-4TC	4 thermocouple	65×90×90mm
11060-00227	IVC-EH-4PT	4 thermal resistance	65×90×90mm
11060-00269	IVC-EH-PWR	Power supply, AC220V input, 24V/0.5A output, 5V/0.6A output	65×90×90mm

● IVC PLC spare part ●

Material code	Model	Description	Dimension
67005-00004	IVC-SL1	PLC-VS HMI 232 communication cable (2m)	2m
67005-00001	IVC-SL2	PLC download cable, USB-RS232 (Port0)(2m)	2m
67005-00002	IVC-SL3	PLC-VT/VK/VA HMI 232 communication cable (3m)	3m
67005-00003	IVC-SL4	HMI download cable, available for VT/VK/VA/Vs series (2m)	2m
67005-00259	IVC-SL5	PLC-VT/VK/VA HMI 232 communication cable (7m)	7m
67005-00391	IVC-SL8	PLC-VS HMI 232 communication cable (7m)	7m
67005-00392	IVC-SL9	IVC1L extension cable (1m)	1m

Medium PLC

Industrial control technology based on the CODESYS platform



System composition

The AX series controller is a motion control programmable controller for multi-axis motion control and high-order motion control needs based on the CODESYS platform and EtherCAT bus technology. It adopts modular design, integrates rich communication interfaces and high-level motion control functions, and quickly builds an industrial control network.

- CPU module
- Power supply module
- Digital input/output module
- Analog input/output module
- Temperature detection module
- EtherCAT communication module

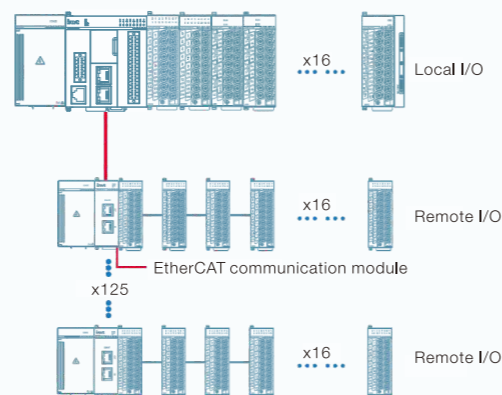

Advanced motion control

The AX series controller integrates rich motion control functions, and realizes high-level motion control such as electronic cam, electronic gear, and synchronous control through high-speed EtherCAT bus or pulse.

Quintic polynomial cam curve processing

- By specifying velocity, position, and acceleration boundary conditions, a continuous trajectory is obtained and the motion trajectory is smoother.

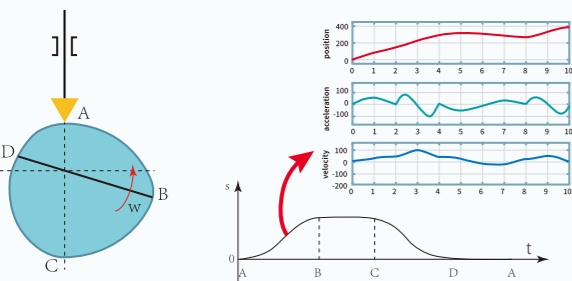

Modify the CAM curve online

- Position compensation is performed for deviations in the trajectory of the motion without the need to regenerate the cam curve.

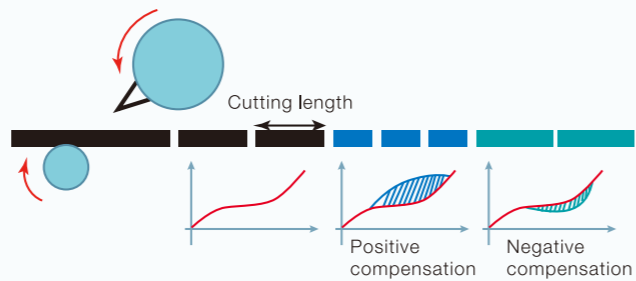

Multi-axis linear interpolation

- The 2/3/4 axes move in a straight line at the same time, supporting relative/absolute position operation.

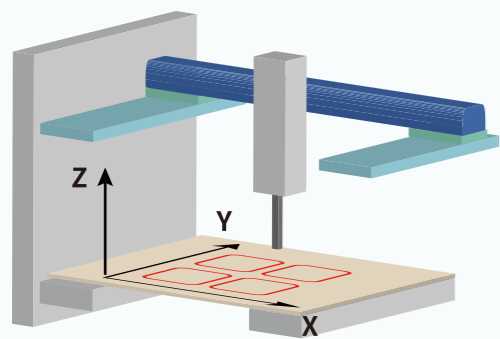

Arc interpolation

- Support plane XY/XZ/YZ any 2-axis arc interpolation, using trigonometric function interpolation, trajectory distortion control within 0.001mm.

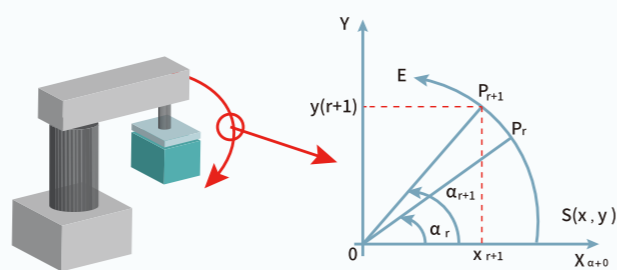

Industry-specific process libraries

The extensive industry application experience helps us to understand customers at a deeper level, and then according to the characteristics of the industry, the common parts of the complex process are extracted and condensed, encapsulated internally, and users only need to simply configure the interface parameters to achieve complex control, effectively shorten the engineer's programming and debugging time, improve efficiency, and reduce costs.

Packaging industry process library

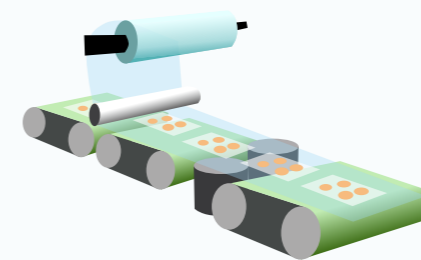

Retract and unwind process library

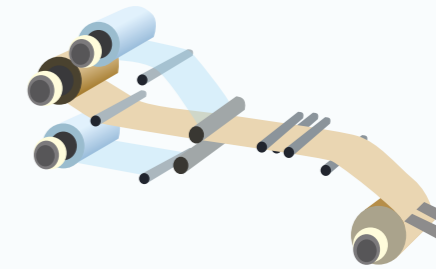

Multi-level open network

The CPU integrates standard common buses and interfaces such as EtherCAT, Ethernet, CANopen, RS485, etc., flexibly deploys communication networks, and creates a highly adaptable automation control system.

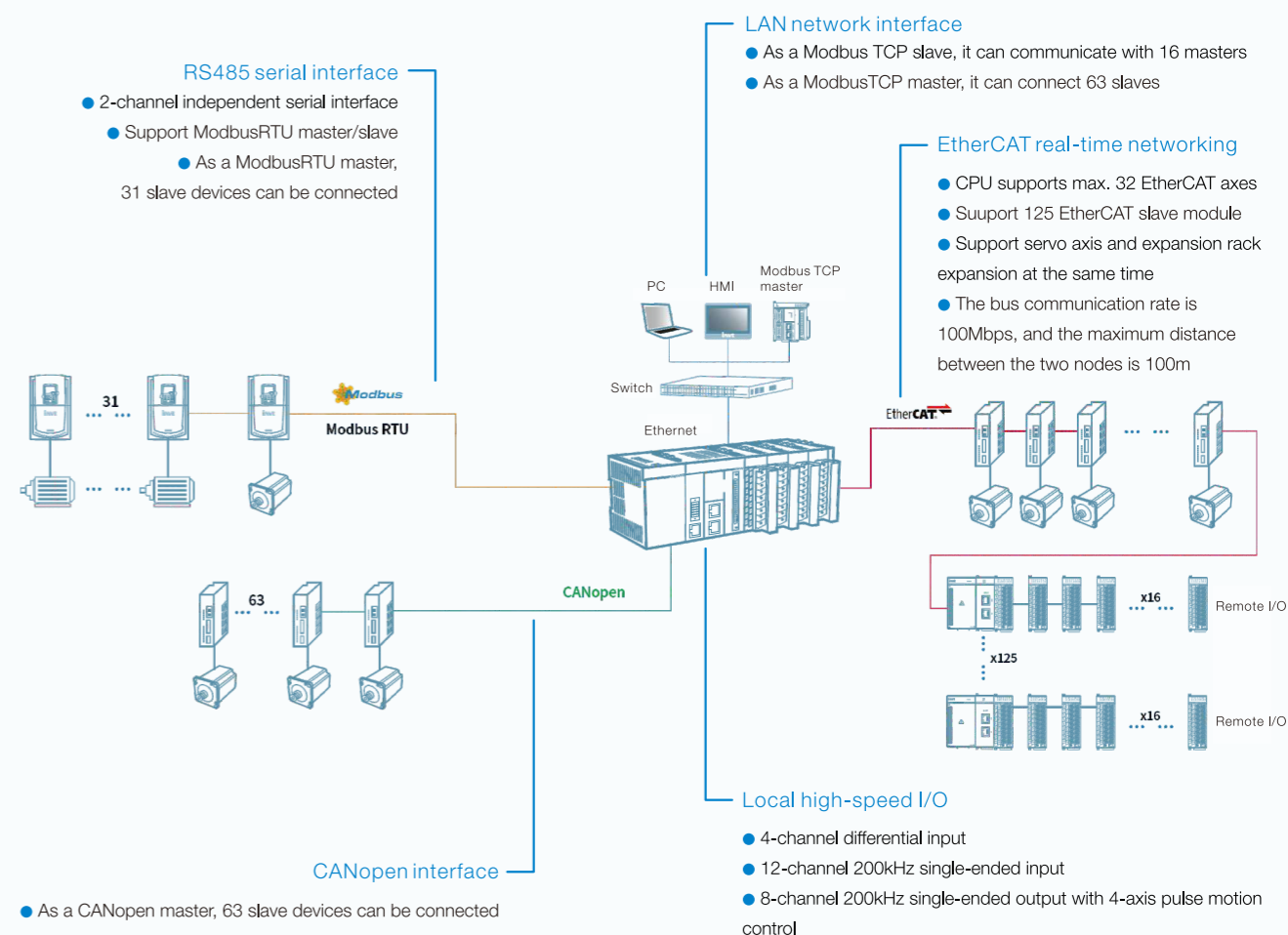

AX series

- EtherCAT bus control on 8/16/32 axes
- High-order motion control such as electronic cams
- Industry-specific process libraries
- 6 standard programming language in IEC61131-3



Technical specification

Model		AX70-C-1608N	AX71-C-1608N	AX72-C-1608N
Rated working voltage		DC24V (-5%~+5%)		
Storage				
Program capacity	Size	10M Word		
	Quantity	POU definition:3000 POU instance:6000		
Data capacity		8M Word		
Power down maintains data capacity		512K Bytes		
Maximum capacity of the SD card		32G		
I/O				
High speed IO		16 channels high-speed input, 8 channels high-speed output		
The maximum number of local extension modules		16	16	16
Max. IO point	Local	256	256	256
	EtherCAT bus	32000	16000	8000
High speed input		4 differential input + 12 200kHz single-ended input, supports 8 single-phase or A/B phase high-speed counting (supports 1x and 4x)		
High speed output		8-channel 200kHz single-ended output with 4-axis pulse motion control		
IO interruption		8-channel high-speed interruption		
Communication networks and interfaces				
Ethernet		RJ45x1, 10BASE-T or 100BASE-TX, support PLC software download, ModbusTCP, TCP/IP protocol		
EtherCAT		RJ45x1, 100BASE-TX, the distance between the two slave stations is less than 100m		
CANopen		RJ45x1,100BASE-TX		
Serial communication (RS485)		In-line terminals with ModbusRTU master/slave support		
USB		Mini USBx1, PC communication, program download and debugging		
Memory card		Micro SDx1 for field software system upgrades		
Connection between PLCs		Ethernet/ModbusRTU		
PC software connection		Ethernet/Modbus		
Modem connection		Support		
Instruction cycle				
Bit operation time		1ns		
Word operation time		4ns		
Fixed-point operation time		80ns		
Floating-point operation time		150ns		
Motion control				
Control axes	EtherCAT max. control axes	32	16	8
Point movement	Manual function	●	●	●
	Homing function	●	●	●
	Fixed-point function	●	●	●
	Speed control	●	●	●
	Variable speed function	●	●	●
	Emergency stop function	●	●	●
	Halt function	●	●	●
	Reset function	●	●	●
	Position overlay function	●	●	●
	Magnification change function	●	●	●
	Time position control	●	●	●
	Time speed control	●	●	●
	Interpolation function (pulse)	Linear interpolation	4 axes, 200kHz, supporting three modes, pulse + sign, forward/reverse pulse train, and quadrature coded pulse	
Planar arc interpolation		2 axes, 200kHz, supporting three modes, pulse + sign, forward/reverse pulse train, and quadrature coded pulse		

Model		AX70-C-1608N	AX71-C-1608N	AX72-C-1608N
Motion control				
Electronic cam	Max. quantity of cam table	64 tables		
	Max. points of total cam tables	4194240		
	Max. points of single cam table	65535		
Electronic gear		●		
Motion control cycle		The EtherCAT data communication cycle uses the same control cycle; the pulse communication cycle is 1ms		
Position unit		Pulse count, millimeters, inches		
The maximum number of axes for		4 axes, 200kHz, support pulse + sign, forward/reverse pulse train and quadrature coded pulse three		
Clock				
Internal clock		When the ambient temperature is 55 °C: the error is -3.5 ~ +0.5 minutes / month When the ambient temperature is 25 °C: the error is -1.5 ~ +1.5 minutes / month When the ambient temperature is 0 °C: the error is -3 ~ +1 minute / month		
Configuration programming				
Programming platform		Invtronic Studio		
programming language		IL, ST, FBD, LD, CFC, SFC		
Basic specification				
Operating ambient temperature		-10~55°C		
Operating ambient humidity		10%~95% (No condensation)		
Storage ambient temperature		-40~70°C		
Storage ambient humidity		10%~100% (Non-condensing)		
IP rating		IP20		
Operating environment		No corrosive gases		
Altitude		2000 meters or less above sea level		
Installation location		Inside the control cabinet		
Degree of contamination		2 or less: Compliant with IEC61131-2		
Surges		2kV		
Anti-interference		Power cord 2kV (according to IEC61000-4-4 standard)		
Electrostatic rating		6kV CD or 8kV AD		
Vibration resistant		3.5mm amplitude within 5~8.5Hz; 10m/s ² acceleration within 8.5~150Hz; X/Y/Z axis, 10 cycles		
Dimensions and weight				
Dimension (WxHxD)		80x90x95mm (excl. terminal) 80x90x113mm (incl. terminal)		
Weight		0.38kg		

Note: ● indicates support; ◻ indicates not support



AX series extension module specification

● Power supply module



Model	AX-PWR
Input power	AC100~240V (-15%~+10%)
Input frequency	50/60Hz (-5%~+5%)
Output voltage	DC24V (-5%~+5%)
Output current	2A
Efficiency	>70%
Overcurrent protection	Support
Fuse	Built-in
Dimension (WxHxD)	50x90x95mm
Material code	11015-00002

● Digital input module



Model	AX-EM-1600D
Internal power supply	5VDC (-10%~+10%)
Extend bus consumption	5V/50mA
Number of channels	16
Input type	NPN/PNP
Input voltage	DC24V
Input current	4.7mA
Port filtering time	10ms
Logic 1 signal	≥15V DC
Logic 0 signal	≤5V DC
Isolation mode	Photocoupler isolation
Dimension (WxHxD)	32x90x117mm
Material code	11015-00004

● Digital output module



Model	AX-EM-0016DP
External power supply	DC24V (-15%~+5%)
Internal power supply	5VDC (-10%~+10%)
Extend bus consumption	5V/60mA
Number of channels	16
Output type	Transistor PNP output, active-high
Output voltage	12V~24V (-15%~+5%)
Max. load	0.5A/point; 2A/Common side (resistive load)
Leakage current at each point	<10uA
OFF→ON response time	Max. 0.5ms (100mA/24VDC)
ON→OFF response time	Max. 0.5ms (100mA/24VDC)
Isolation mode	Magnetic isolation
Short-circuit resistant output	Yes (Limit maximum current to 1.7A during protection)
Dimension (WxHxD)	32x90x117mm
Material code	11015-00005



Model	AX-EM-0016DN
External power supply	DC24V (-15%~+5%)
Internal power supply	5VDC (-10%~+10%)
Extend bus consumption	5V/60mA
Number of channels	16
Output type	Transistor NPN output, active low
Output voltage	12V~24V (-15%~+5%)
Max. load	0.5A/point; 2A/Common side (resistive load)
Leakage current at each point	<9uA
OFF→ON response time	Max. 0.5ms (100mA/24VDC)
ON→OFF response time	Max. 0.5ms (100mA/24VDC)
Isolation mode	Magnetic isolation
Short-circuit resistant output	Yes (Limit maximum current to 1.7A during protection)
Dimension (WxHxD)	32x90x117mm
Material code	11015-00006

● Analog input module



Model	AX-EM-4AD
Internal power supply	5VDC (-10%~+10%)
Extend bus consumption	5V/138mA
Number of channels	4
Voltage range	-10V~+10V, -5V~+5V, 0~5V, 0~10V
Current range	-20mA~+20mA, 0~20mA, 4~20mA
Resolution	24bit
Normal temperature accuracy (25°C)	Voltage±0.1%FS, current±0.1%FS
Conversion speed	1ms/channel
Limit voltage	±12V
Limit current	±24mA
Max. common-mode voltage between channels	30VDC
Isolation mode	Between I/O ports and power supplies: Isolated channels: Not isolated
Dimension (WxHxD)	32x90x117mm
Material code	11015-00007

● Analog output module



Model	AX-EM-4DA
External power supply	24VDC (-15%~+20%)
Internal power supply	5VDC (-10%~+10%)
Extend bus consumption	5V/100mA
Number of channels	4
Voltage range	-10V~+10V, -5V~+5V, 0~5V, 0~10V
Current range	0~20mA, 4~20mA
Resolution	16bit
Normal temperature accuracy (25°C)	Voltage±0.1%FS, current±0.1%FS
Conversion speed	1ms/channel
Voltage output load	10kΩ~1MΩ
Current output load	0Ω~1kΩ
Isolation mode	Between I/O ports and power supplies: Isolated channels: Not isolated
Dimension (WxHxD)	32x90x117mm
Material code	11015-00010

● Temperature detection module



Model	AX-EM-4PTC
Internal power supply	5VDC (-10%~+10%)
Extend bus consumption	5V/150mA
Number of channels	4
Wiring method	2/3/4 wirings
Thermal resistance	Pt100, Pt500, Pt1000, CU100
Thermocouple	B, E, J, K, N, R, S, T
Resolution	24bit
Sensitivity	0.1° C/° F
Sampling period	1.5s/channel
Normal temperature accuracy (25°C)	Thermal resistance: ±0.3%FS Thermocouple: ±0.1%FS±1° C
Operating temperature accuracy	Thermal resistance: ±1%FS Thermocouple: ±0.3%FS±1° C
Cold junction compensation	Inside/Outside
Isolation mode	Between I/O ports and power supplies: Isolated channels: Not isolated
Dimension (WxHxD)	32x90x117mm
Material code	11015-00009

● Communication module

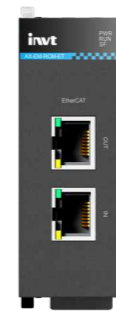

Model	AX-EM-RCM-ET
Power supply	24VDC (-15%~+20%)
Communication protocols	EtherCAT
Synchronization mode	I/O uses input-output synchronization
Physical layer	100Base-TX
Transmission rate	100Mbps
Transmission distance	Maximum 100m between two nodes
Number of slaves	1~125, The internal address is automatically arranged by the network bus connection sequence
Duplex mode	Full duplex
Topology	Linear
Process data	A single Ethernet frame can be up to 1486 bytes in size
Refresh time	1000 switching inputs and outputs are approximately 30us
Dimension (WxHxD)	32x90x95mm
Material code	11015-00008

AX series product dimension

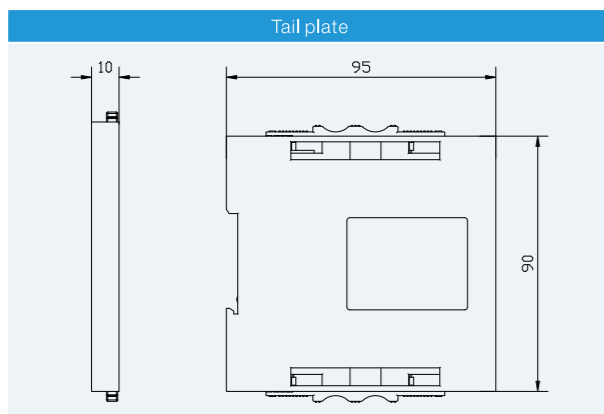
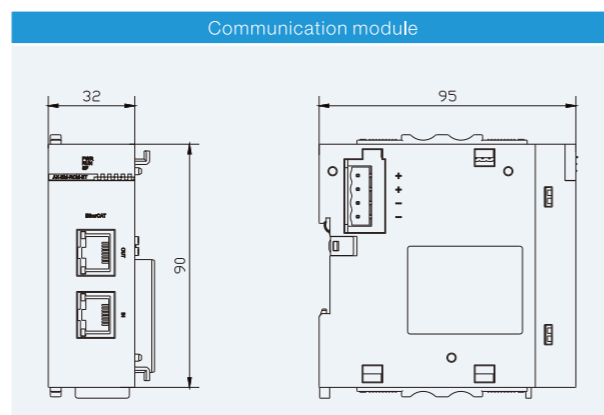
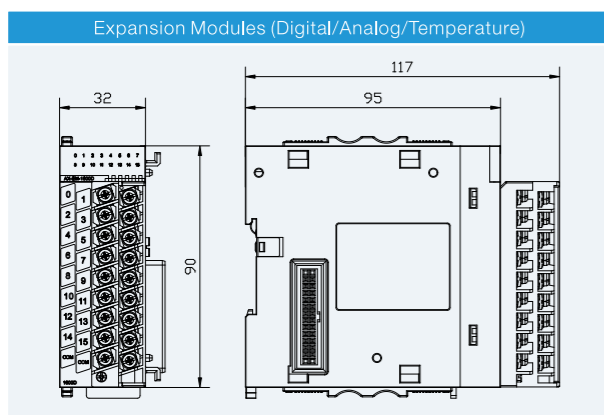
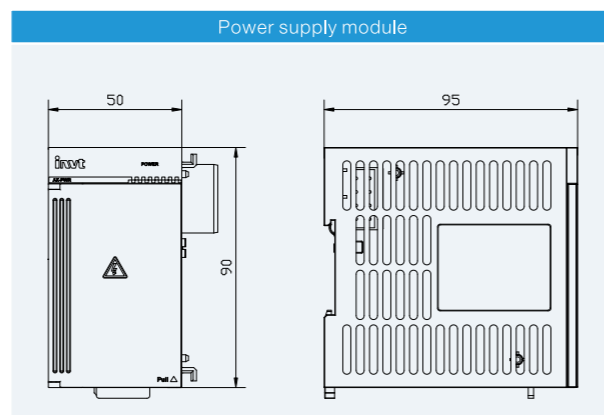
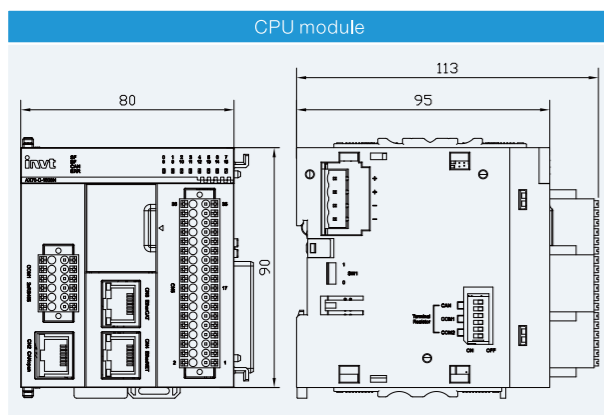

Distributed I/O

A distributed I/O network built based on EtherCAT

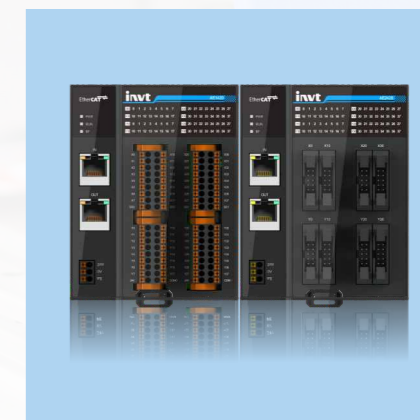

Medium PLC product list

Material code	Model	Description	Dimension
11015-00014	AX70-C-1608N	CPU module; EtherCAT(32axes)/CANopen/Ethernet, RS485x2, NPN output; RoHS	80x90x113mm
11015-00013	AX71-C-1608N	CPU module; EtherCAT(16axes)/CANopen/Ethernet, RS485x2, NPN output; RoHS	80x90x113mm
11015-00015	AX72-C-1608N	CPU module; EtherCAT(8axes)/CANopen/Ethernet, RS485x2, NPN output; RoHS	80x90x113mm
11015-00002	AX-PWR	Power supply module; Input:100~240VAC50Hz/60Hz, output:2A, 24VDC; RoHS	32x90x95mm
11015-00004	AX-EM-1600D	Digital input module; 16-point input, 24VDC, NPN/PNP; RoHS	32x90x117mm
11015-00005	AX-EM-0016DP	Digital output module; 16-point PNP output, 500mA, 24VDC; RoHS	32x90x117mm
11015-00006	AX-EM-0016DN	Digital output module; 16-point NPN output, 500mA, 24VDC; RoHS	32x90x117mm
11015-00007	AX-EM-4AD	Analog input module; 4 channels, 24bit resolution, accuracy±0.1%; RoHS	32x90x117mm
11015-00010	AX-EM-4DA	Analog output module; 4 channels, 16bit resolution, accuracy±0.1%; RoHS	32x90x117mm
11015-00008	AX-EM-RCM-ET	Communication module; EtherCAT slave module, support 16I/O modules; RoHS	32x90x95mm
11015-00009	AX-EM-4PTC	Temperature detection module; 4 channels, 24bit resolution, 0.1° C/° F; RoHS	32x90x117mm

AE series

- Standard EtherCAT slave interface is compatible with many types of EtherCAT controllers on the market
- Lightning protection, surge prevention, stable operation
- The overall width is 90mm, and the high-density terminals effectively save space in the cabinet
- Push-In Design quick-connect anti-shedding terminals, easy to connect and insert, reliable clamping wire, vibration resistance
- 500µs scan cycle, 1µs communication delay, and DC/SM synchronization, to build a high performance control network with the servo
- Digital module compatible with NPN/PNP inputs, allowing manual change from default NPN outputs to PNP outputs, flexible application, reducing the types of stocking



Technical specification

Material code	11016-00001	11016-00002
Model	AE1420	AE2420
Input voltage	24VDC (-15%~+20%) /0.5A	
EtherCAT		
Communication protocols	EtherCAT industrial real-time bus protocol	
Physical layer	100Base-TX	
Transmission rate	100Mbps	
Duplex mode	Full duplex	
Synchronization mode	DC/SM synchronization	
Scan cycle	Minimum 500µs	
Communication delay	<1us	
Transmission distance	Maximum 100m between two nodes	
Topology	Linear topology	
Digital input		
Input channel	32	
Input connection mode	Straight plug-in terminals	Cow terminals
Input voltage level	24VDC (max. 30VDC)	
Input current	4.7mA	
Logic 1 signal	≥15V DC	
Logic 0 signal	≤5V DC	
Port filtering time	3ms	
Input impedance	5.4kΩ	
Input signal form	Voltage DC input	
Isolation mode	Photocoupler isolation	
Digital output		
External 24V voltage	24VDC (-15%~+20%)	
Output channel	32	
Output connection mode	Straight plug-in terminals	Cow terminals
Output type	Default NPN type (can be switched to PNP type via DIP switch)	
short-circuit protection	Yes (built-in recoverable fuse)	
OFF→ON response time	Max. 0.5ms (100mA/24VDC)	
ON→OFF response time	Max. 0.5ms (100mA/24VDC)	
Maximum load	0.5A/point; 2A/Common side (resistive load)	
Isolation mode	Magnetic isolation	
Environmental conditions		
Operating temperature	-25° C~+55° C	
Storage temperature	-40° C~+70° C	
Relative humidity	10%~100% (No condensation)	
Dimension and weight		
Dimension(W×H×D)	90×115×94.6mm	90×115×101.1mm
Weight	0.34kg	0.31kg

Dimensi

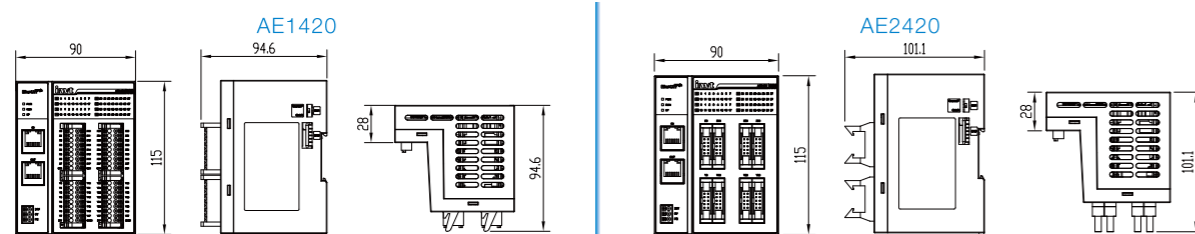

HMI

Friendly human-machine interaction experience



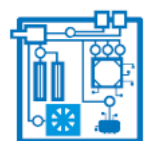

Powerful CPU

- Stable, efficient, safe, and reliable run in Linux.
- Industrial-grade high-performance processor.
- 256MB FLASH+512MB DDR3.



Diversified communication

- Multi-serial communication (RS232/422/485).
- Ethernet communication.
- Allowing one screen or multi-screen for one machine, or multi-screen for multi-machine.



Convenient configuration

- Multi-set recipes, multi-window function.
- Data acquisition, data alarm function.
- Macros are supported.
- Support for custom vector graphics.

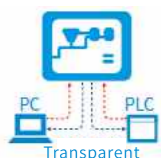

Featured function

- PC can communicate directly with the PLC via the HMI.
- Online simulation function, PC can be directly connected to the PLC simulation configuration project.
- USB, Ethernet, U disk three ways to update the configuration of the project.



Language font

- Supports up to 50 languages.
- Supports TRUE TYPE (TTF) font.
- Supports font editing for complex properties.
- Unicode international standard code.



Safe and reliable

- Industrial-grade design, stable operation.
- High-capacity FLASH supports permanent storage of large capacity data without loss of power.
- Support USB flash drive data storage.
- New password mechanism, more secure and reliable to use.

TC series

- 4.3/7.0/10.1/15.6"
- 16.77 million colors of true color display
- Backlight life 50,000hr
- C language macros
- 7.0 inches or more support SD card



Technical specification

Model	TC3043H	TC6070W	TC6070WE	TC6100WE	TC6156H
Display					
Display size	4.3"	7"	7"	10.1"	15.6"
Resolution	800x480	1024x600	1024x600	1024x600	1920x1080
Screen material	TFT				
Color depth	24 bits				
Brightness (cd/m²)	250	350	350	400	250
Backlight type	LED				
Backlight life (hr)	50000				
Touch panel type	4-wire industrial resistive screen				
CPU and memory					
CPU	Cortex-A8 600MHz				Cortex-A8 1GHz
Memory	64M DDR3	128M DDR3	128M DDR3	128M DDR3	512M DDR3
Flash	128M Flash	128M Flash	128M Flash	128M Flash	256M Flash
Number of screens	7999 pages				
Communication interface					
USB	USB Client 2.0x1 USB Host 2.0x1				
Serial * interface	COM1	RS232/RS485/RS422			
	COM2	-	RS485 (DB9)	RS485 (DB9)	RS485 (DB9)
	COM3	RS232 (DB9)	RS232 (DB9)	RS232 (DB9)	RS232 (DB9)
Ethernet	10M/100M BASE-Tx1		10M/100M BASE-Tx1		10M/100M BASE-Tx2
SD card slot	-	SD	SD	SD	Micro SD
Power supply					
Rated voltage	DC24V, working voltage range: 9V~28V				
Rated power	2.5W	10W	10W	10W	18W
Environment					
Work temperature	0~50 °C				
Work humidity	10~90%RH (No condensation)				
Protection level	IP65 (front board)				
Certification					
CE	EN61000-6-2:2005;EN61000-6-4:2007				
RoHS	•	•	•	•	•
Dimensions and weight					
Physical dimension W*H*D (mm)	138x86x32	204x145x33.8	204x145x33.8	273x213x36	394x256x36
Hole dimension A*B (mm)	132x80	192x138	192x138	260x202	380x245 or VESA installation
Weight (Kg)	0.3Kg	0.56Kg	0.56Kg	0.92Kg	2.25Kg
configuration					
Configuration software	INVT TC Studio Pro				

Note: • Indicates Support - Indicates not supported * In the serial interface, DB9 is a male socket

Dimension

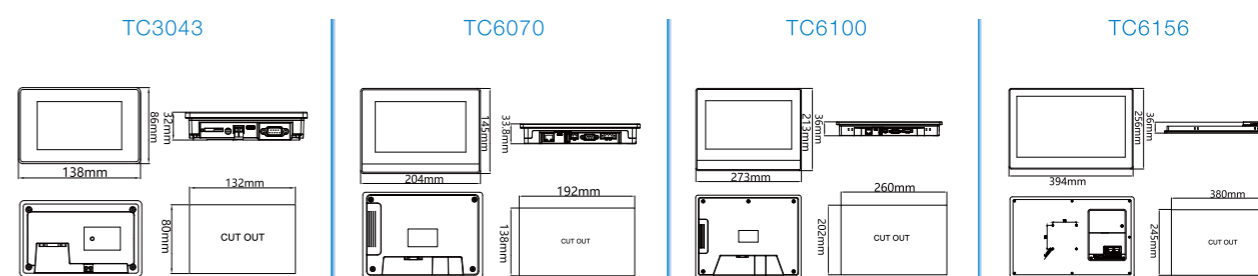

VS series

- 4.3/7.0/10.2"
- 16.77 million colors of true color display
- Backlight life 20,000hr
- C language macros



Technical specification

Model	VS-043FE	VS-043HS	VS-070HE-1	VS-070HS	VS-102HC	VS-102HCS
Display						
Display size	4.3"	4.3"	7"			10.2"
Resolution	480x272	640x480	800x480			1024x600
Screen material			TFT			
Color depth			24 bits			
Brightness (cd/m²)	400	400	450			500
Backlight type			LED			
Backlight life (hr)			20000			
Touch panel type			4-wire industrial resistive screen			
CPU and memory						
CPU			Cortex-A8 600MHz			
Memory			128M DDR3			
Flash			128M Flash			
Communication interface						
USB			USB Host: USB2.0x1 / USB Client: USB2.0x1			
Serial interface *		COM:RS232/422/485 (DB9)		COM1:RS232/422/485 (DB9)	COM2:RS232/422/485 (DB9)	
Ethernet interface	-	10/100M BASE-Tx1	-	10/100M BASE-Tx1	-	10/100M BASE-Tx1
Micro SD card slot						
Power supply						
Rated voltage			24VDC (±15%)			
Rated power		3W		5W		7W
Environment						
Work temperature			-20~55°C			
Work humidity			5~95%RH (No condensation)			
Protection level			IP65 (Front board)			
Certification						
CE			EN55032, EN55035			
FCC compatibility			FCC, Class A			
RoHS	•	•	•	•	•	•
Dimensions and weight						
Physical dimension W*H*D (mm)	150x93x39	173x95x39	203x145x40			274x180x40
Hole dimension A*B (mm)	141x84	163x85	192x138			255x167
Weight (Kg)		0.27Kg	0.7Kg			1Kg
Configuration						
Configuration software			HMITOOL			

Note: • Indicates Support - Indicates not supported * In the serial interface, DB9 is a male socket

Dimension

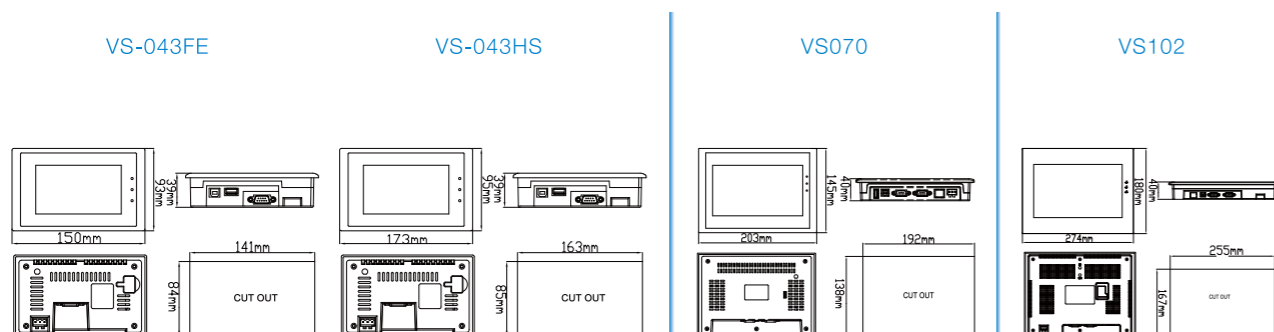

VA series

- 7.0/10.1"
- 3 serial ports
- Backlight life 20,000hr
- Up to 30 screens, 100 macros



Technical specification

Model	VA2070-NOCXR	VA2100-NOCXR	
Display			
Display size	7"	10.1"	
Resolution	800x480	1024x600	
Screen material		TFT	
Color depth		16 bits	
Brightness (cd/m²)	350	250	
Backlight type		LED	
Backlight life (hr)		20000	
Touch panel type		4-wire resistive screen	
CPU and memory			
CPU		RISC ARM9 32Bit 300MHz	
Memory		64MB DDR3	
Flash		128MB Flash	
Number of screens		30 pages	
Interface			
USB		Host: USB2.0x1 / Client: USB2.0x1	
Serial interface *	COM1	RS232 (DB9)	RS232 (DB9)
	COM2	RS485/422 (DB9)	RS485/422 (DB9)
	COM3	RS485 (DB9)	RS485 (DB9)
Ethernet interface	-	-	-
Micro SD card slot			
Power supply			
Rated voltage		24VDC (±10%)(Isolation)	
Rated power	10W		20W
Environment			
Work temperature		-10~50°C	
Work humidity		10~90%RH (No condensation)	
Protection level		IP54 (Front board)	
Certification			
CE		EN61000-6-2, EN61000-6-4	
FCC compatibility		FCC, Class A	
RoHS	•		•
Dimensions and wight			
Physical dimension W*H*D (mm)	203.5x148.5x31.5		270.8x212.8x42.5
Hole dimension A*B (mm)	191.5x138		259x201
Weight (Kg)	0.55Kg		1.1Kg
Configuration			
Configuration software			VT Designer

Note: • Indicates Support - Indicates not supported * In the serial interface, DB9 is a female socket

Dimension

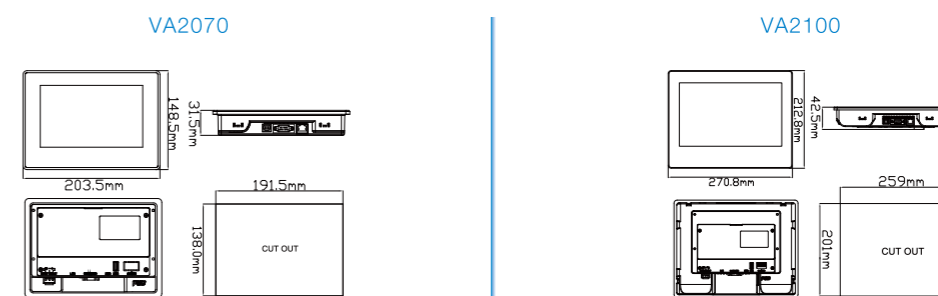

VK series

- 4.3/7.0/10.1"
- 3 serial ports
- Backlight life 20,000hr
- Support macros



Technical specification

Model	VK2043-N0CXN	VK2043-N0CXR	VK2043-N0EXR	VK2070-N0EXR	VK2070-N0CXR	VK2100-N0CXR	VK2100-N0EXR	
Display								
Display size	4.3"	4.3"	4.3"	7"	7"	10.1"	10.1"	
Resolution	480x272	480x272	480x272	800x480	800x480	1024x600	1024x600	
Screen material	TFT							
Color depth	16 bits							
Brightness (cd/m ²)	400	400	400	400	400	350	350	
Backlight type	LED							
Backlight life (hr)	20000							
Touch panel type	4-wire resistive screen							
CPU and memory								
CPU	RISC ARM9 32Bit 300MHz							
Memory	64MB DDR3							
Flash	128MB Flash							
Number of screens	7999 pages							
Interface								
USB	USB Host: USB2.0x1 / USB Client: USB2.0x1							
Serial interface	COM1	-	RS232 (5-PIN terminal connector)	-				RS232 (DB9)
	COM2	-	RS422/485 (5-pin terminal connector)	-				RS422/485 (DB9)
	COM3	RS485 (5-pin terminal connector)			-			
Ethernet interface	-	-	10M/100M BASE-Tx1	10M/100M BASE-Tx1	-	-	10M/100M BASE-Tx1	
Micro SD card slot	-							
Power supply								
Rated voltage	24VDC (±10%)(Isolation)							
Rated power	10W	10W	10W	20W	20W	20W	20W	
Environment								
Work temperature	-10~60° C							
Work humidity	10~90%RH (No condensation)							
Protection level	IP65 (Front board)							
Certification								
CE	EN61000-6-2, EN61000-6-4							
FCC compatibility	FCC, Class A							
RoHS	●	●	●	●	●	●	●	
Dimensions and weight								
Physical dimension W*H*D (mm)	129x103x33	129x103x33	129x103x33	203.5x148.5x37	203.5x148.5x37	270.8x212.8x42.5	270.8x212.8x42.5	
Hole dimension A*B (mm)	118.5x92.5	118.5x92.5	118.5x92.5	191.5x138	191.5x138	259x201	259x201	
Weight (Kg)	0.23Kg	0.23Kg	0.23Kg	0.55Kg	0.55Kg	1.1Kg	1.1Kg	
Configuration								
Configuration software	VT Designer							

Note: ● Indicates Support - Indicates not supported * In the serial interface, DB9 is a female socket

Dimension

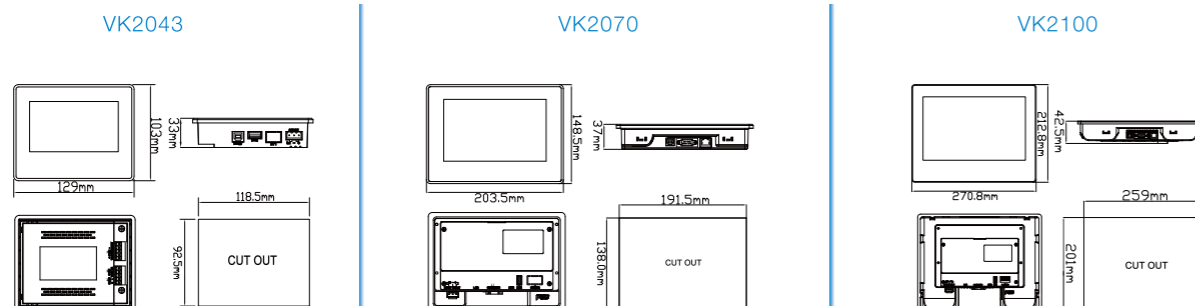

VT series

- 7.0/10.4"
- Up to 5 serial ports
- Isolation design
- Backlight life 20,000hr
- Support macros



Technical specification

Model	VT2070-N0CTR-24	VT2070-H1ETR-31	VT2104-H0ETR-51	
Display				
Display size	7"	7"	10.4"	
Resolution	800x480	800x480	800x600	
Screen material	TFT			
Color depth	16 bits			
Brightness (cd/m ²)	400			
Backlight type	LED			
Backlight life (hr)	20000			
Touch panel type	4-wire resistive screen			
CPU and memory				
CPU	RISC ARM9 32Bit 300MHz			
Memory	64MB DDR3			
Flash	128MB Flash			
Number of screens	7999 pages			
Interface				
USB	USB Host: USB2.0x1 / USB Client: USB2.0x1			
Serial interface	COM1	RS232 (DB9)	RS232/422/485 (DB9)	RS232 (DB9)
	COM2	RS422/485 (DB9)	RS485 (5-PIN terminal)	RS422/485 (DB9)
	COM3	-	RS485 (DB9)	RS485 (DB9)
	COM4	-	-	RS485 (5-pin terminal)
	COM5	-	-	RS485 (5-pin terminal)
Ethernet interface	-	-	10/100M BASE-Tx1	10/100M BASE-Tx1
Micro SD card slot	-	-	Micro SD	-
Power supply				
Rated voltage	24VDC (±10%)(Isolation)			
Rated power	20W	20W	20W	
Environment				
Work temperature	-10~60° C			
Work humidity	10~90%RH (No condensation)			
Protection level	IP66 (Front board)			
Certification				
CE	EN61000-6-2, EN61000-6-4			
FCC compatibility	FCC, Class A			
RoHS	●	●	●	
Dimensions and weight				
Physical dimension W*H*D (mm)	188x143.3x40	188x143.3x40	270.8x212.8x42.5	
Hole dimension A*B (mm)	174.5x132.5	174.5x132.5	259x201	
Weight (Kg)	0.55Kg	0.55Kg	1.1Kg	
Configuration				
Configuration software	VT Designer			

Note: ● Indicates Support - Indicates not supported * In the serial interface, DB9 is a female socket

Dimension

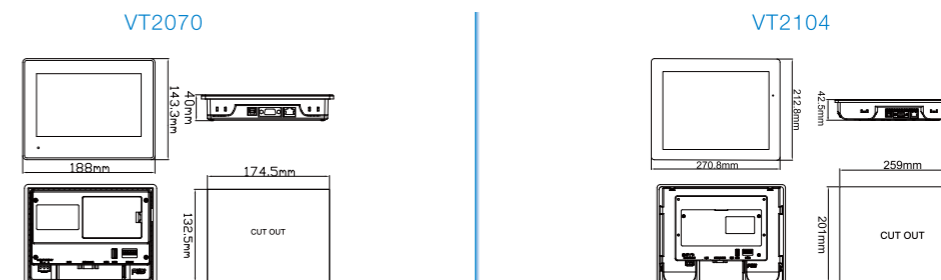

Industrial Internet

Cloud platform | Application system | Cloud platform | Cloud services

HMI product list

Product	Material code	Model	Description	Cut-out size
VS series	11060-00183	VS-043FE	4.3", 480x272, 16bit color, 1 serial port, no Ethernet port	141x84mm
	11060-00241	VS-043HS	4.3", 480x272, 16bit color, 1 serial port, 1 Ethernet port	163x85mm
	11060-00187	VS-070HS	7.0", 800x480, 16bit color, 2 serial ports, 1 Ethernet port	192x138mm
	11060-00186	VS-070HE-1	7.0", 800x480, 16bit color, 1 serial port, no Ethernet port	192x138mm
	11060-00188	VS-102HC	10.2", 1024x600, 16bit color, 2 serial port, no Ethernet port	255x167mm
	11060-00189	VS-102HCS	10.2", 1024x600, 16bit color, 2 serial ports, 1 Ethernet port	255x167mm
	11060-00235	VS070-1614MDR1	7.0" HMI PLC integrated machine, 16 DI, 14 DO, 2 AI, 1 AO, no Ethernet port	192x138mm
TC series	11026-00020	TC3043H	4.3", 800x480, 16bit color, 2 serial port, no Ethernet port	132x80mm
	11026-00021	TC6070W	7.0", 1024x600, 24bit color, 3 serial ports, no Ethernet port, support SD card	192x138mm
	11026-00019	TC6070WE	7.0", 1024x600, 24bit color, 3 serial ports, 1 Ethernet port, support SD card	192x138mm
	11026-00015	TC6100WE	10.1", 1024x600, 24bit color, 3 serial ports, 1 Ethernet port, support SD card	260x202mm
	11026-00014	TC6156H	15.6", 1920x1080, 16bit color, 3 serial ports, 2 Ethernet ports	380x245mm or VESA
VA series	11060-00156	VA2070-N0CXN	7.0", 800x480, 16bit color, 3 serial ports, no Ethernet port	191.5x138mm
	11060-00157	VA2100-N0CXN	10.1", 1024x600, 16bit color, 3 serial ports, no Ethernet port	259x201mm
VK series	11060-00172	VK2043-N0CXN	4.3", 480x272, 16bit color, 2 serial ports, no Ethernet port	118.5x92.5mm
	11060-00272	VK2043-N0EXR	4.3", 480x272, 16bit color, 3 serial ports, no Ethernet port	118.5x92.5mm
	11060-00173	VK2043-N0EXR	4.3", 480x272, 16bit color, 3 serial ports, 1 Ethernet port	118.5x92.5mm
	11060-00169	VK2070-N0EXR	7.0", 800x480, 16bit color, 3 serial ports, 1 Ethernet port	191.5x138mm
	11060-00171	VK2070-N0CXN	7.0", 800x480, 16bit color, 3 serial ports, no Ethernet port	191.5x138mm
	11060-00168	VK2100-N0CXN	10.1", 1024x600, 16bit color, 3 serial ports, no Ethernet port	259x201mm
	11060-00167	VK2100-N0EXR	10.1", 1024x600, 16bit color, 3 serial ports, 1 Ethernet port	259x201mm
VT series	11026-00017	VT2070-H1ETR-31	7.0", 800x480, 16bit color, 3 serial ports, 1 Ethernet port	174.5x132.5mm
	11026-00018	VT2070-N0CTR-24	7.0", 800x480, 16bit color, 32 serial ports, no Ethernet port, 1MB (backup)	174.5x132.5mm
	11026-00016	VT2104-H0ETR-51	10.4", 800x600, 16bit color, 5 serial ports, 1 Ethernet port	259x201mm



Industrial Internet solutions

INVT independently develops and owns four series of industrial Internet products of IWOCLOUD Industrial Internet Cloud Platform, IWOScience Application System, IWOLink Data Terminal Products and ICS Industrial Cloud Services, combined with INVT Industrial Automation Family Series products, to provide end-to-end integrated solutions for industry customers and help enterprise customers move towards a new journey of digital transformation!



System features

INVT provides complete, reliable, flexible and fast delivery solutions for industrial enterprises.

- Broad access**
Support a variety of equipment inverter, servo, PLC, HMI
- Multiple displays**
Customizable application system functions
- Privatized deployment**
Including data history, conditional collection, and data reports
- Safe and stable**
Pushing information through mobile app, email, or SMS
- Multimedia access**
Support on-site video image interface access and portrait AI recognition
- Get started quickly**
Simple operation and friendly interface
- Personalization**
Support PC, mobile APP (Android, iOS)
- Data analysis**
The system cloud platform supports privatization deployment
- Alarm push**
Data transmission encryption, multi-server distributed management
- Data interface**
The platform provides API data interface services to eliminate data islands

Multiple ways to sign in

By visiting <https://iot.invt.com/login> on your PC

By installing the INVT-IOT mobile app on your mobile device



Large-screen apps

Provide customized large-screen display applications for system data, mainly planned according to the following aspects:

- Macro data: equipment map distribution, online/fault/alarm equipment distribution
- System key statistics: equipment status statistics display, number of work orders display



IWOScience business application system



Realize the collection of equipment monitoring functions in various dimensions to meet the equipment monitoring needs of users in various dimensions, including real-time monitoring of the safe operation of the equipment, monitoring of the efficiency and effectiveness of the equipment operation, and monitoring in the form of large screen.

• Device remote monitoring

The mobile APP, computer web page, large-screen monitoring and other forms can be used to quickly grasp the real-time status of the equipment, video surveillance, remote start and stop, modify parameters, etc.

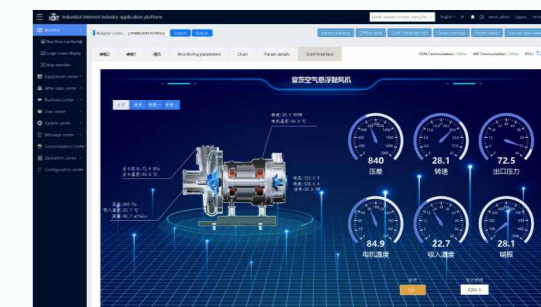

• Fault warning/alarm

For the timely feedback of various types of alarm information generated by the system, the system can push the alarm information of the device through APP, SMS, email and other forms; for the key parameters of the key equipment, the early warning value can be set to prevent the accident before it occurs.

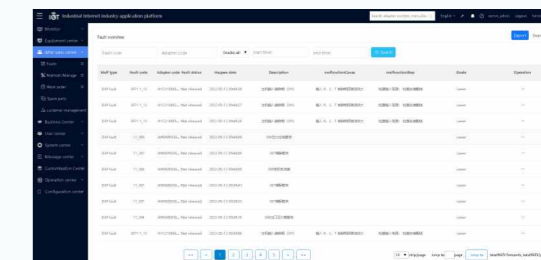



After-sales center

For the collection of equipment after-sales maintenance dimension functions, improve the efficiency of user equipment after-sales maintenance work, including: fault management, maintenance management, work order management, spare parts management, etc.

● After-sales work order management

It can realize the circulation of a series of after-sales work orders such as faults, installation, repair, etc., monitor the whole process of processing process and results, improve the efficiency of after-sales maintenance, and enhance user experience and corporate image.

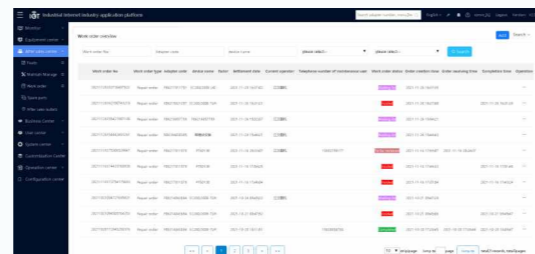

Business Center

The functional collection of equipment-related sales business meets the needs of equipment-related business, including: order management, business opportunity management, payment collection management, process management, etc.

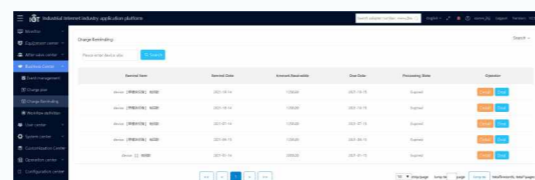

User Center

The functional collection for system users and role permissions satisfies users to implement the distribution of different accounts and permissions, including: user management, organization management, and role management.

● Role permission management

User management: automatically generated by the industrial Internet platform, divided into self-configurable secondary accounts: divided into manufacturers, distributors, terminal users and other types.

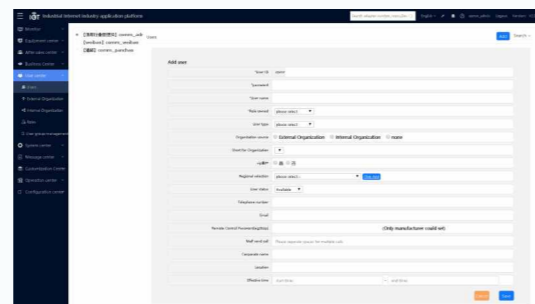

Organizational management: Divided into internal organizations (administrators, operators, etc.), external organizations (dealers, end users) and other types.

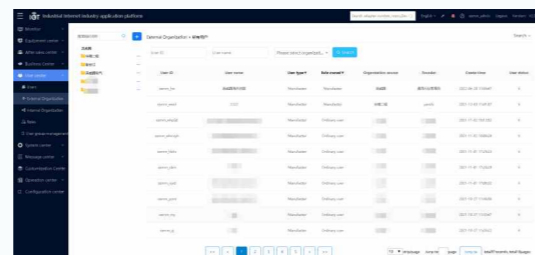

Role permissions: You can define different permissions for different roles.

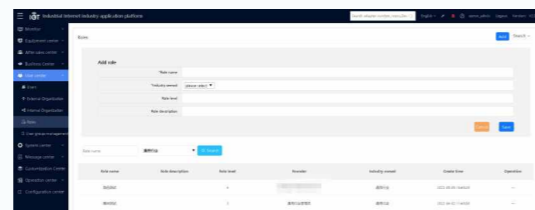

System Center

The set of functions for system operation and daily management of the platform meets the needs of users for system management, including: system settings, operation records, user data statistics, enterprise dynamic management, etc.

● Historical data query

The type, address, type, chart, and fault of the focus parameter can be customized; Data charts can be customized for display, and historical data can be exported to a local server in various types of files.

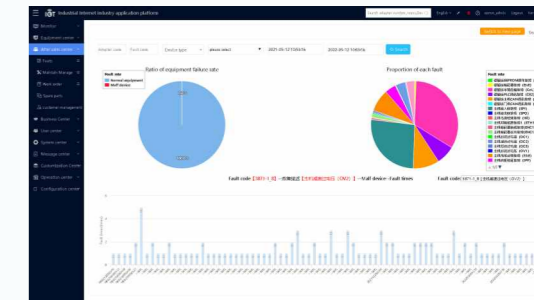

● Data analysis and statistics

For historical data, various statistical reports can be customized to facilitate users to apply data analysis in various dimensions. According to the needs of different users, the assessment and statistical analysis of various parameters of the statistical analysis equipment provide objective data support for the decision-making of various departments such as research and development, aftersales service and sales.

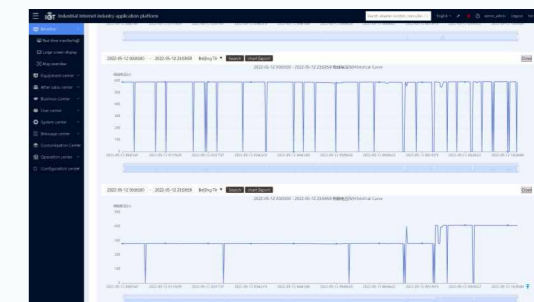

Customization Center

For the collection of customizable functions of the system, it meets the needs of users to quickly realize the implementation of custom functions, including: material management, configuration management, parameter management, report management, etc.

● Personalized configuration

The system platform supports users to configure various forms of functional components and configuration screens according to their own enterprise management characteristics.



Fulfillment Center

For the collection of equipment leasing business functions, to meet the user leasing business development, including: parts management, project/contract management, report management, process management, etc.

● Equipment operation management

In view of the needs of contract energy management business, we have developed mature applications such as contract management, payment collection management, electronic fence, spare parts management, remote locking, process approval management, etc

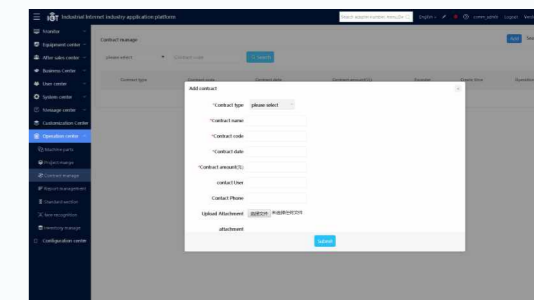

IWOLink data terminal products

In order to flexibly adapt to the data acquisition needs of various industrial devices and different network scenarios, INV T has launched a series of data acquisition products to provide fast, easy and secure IoT data connection solutions.



Technical specification

Model	ICA1010-02	ICA100-01F	ICA100-02	ICA200-02	ICA400-01	ICA401-01	ICA413-02-CN	ICA400-02-CN	ICA417-02-CN	
Upstream networking	Ethernet	WiFi	WiFi	2G	4G full Netcom	4G full Netcom	4G full Netcom/Ethernet	4G full Netcom	4G full Netcom/Ethernet	
Network bandwidth	10/100Mbps	20/40MHz Max.150Mbps	20/40MHz Max.150Mbps	Up: 107Kbps Down: 85.6Kbps	Up: 150Kbps Down: 50Kbps	Up: 150Kbps Down: 50Kbps	Up: 10Kbps Down: 5Kbps	Up: 10Kbps Down: 5Kbps	Up: 150Kbps Down: 50Kbps	
Downstream communication	RS485x1	RS485x1	RS485x1	RS485x1	RS485x1	Ethernetx1	RS485x1+ Ethernetx1	RS485x1	RS485x1/Ethernetx3	
Protection class	IP20									
Supply voltage	10~24V									
Power consumption	5W									
Indicator light	Power indicator, network status light, operating status light									
Antenna	/	Rod antenna	Tower suction cup antenna							Round chuck antenna
Installation mode	Standard rail mounting									
Dimension	96.7x70x26.4mm		110x86x27mm		96.7x70x26.4mm		120x50x35mm		100x95x27mm	
Operating temperature	-25~75 ° C									
Data monitoring	Supported									
Edge computing	Not supported			Non-standard support						
OTA remote upgrade	Not supported			Supported						
Normal transparent transmission	Not supported			Supported						
VPN transparent	Not supported								Supported	
Product positioning	Ethernet version	Internet WiFi version	WiFi version	2G standard version	4G standard version	4G standard version	4G standard version	4G youth version	4G ultimate version	

Dimension

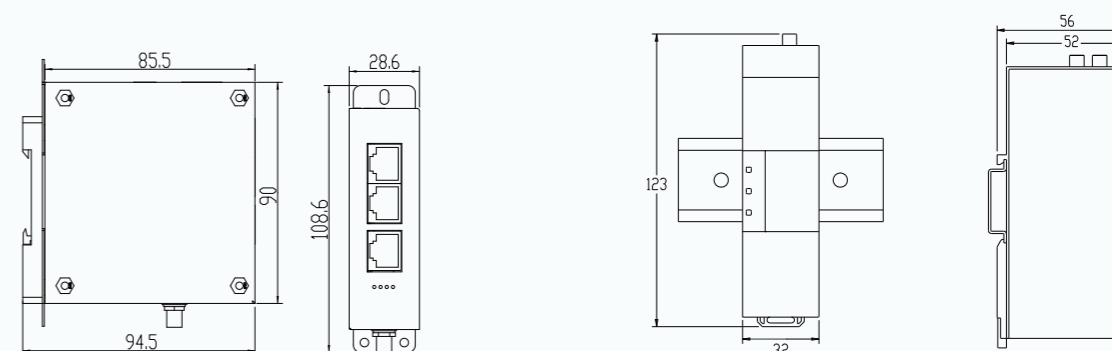

Model	Dimension (WxHxD)	Weight
ICA417 series	28.6x108.6x94.5mm	130g

Model	Dimension (WxHxD)	Weight
ICA413 series	32x123x56mm	130g

Technical features

No.	Functional classification	ICA417 series specification		
1	Supported networks	Up	4G	LTE FDD, LTE TDD, GSM
		DOWN	WAN	10/100M self-adapted port
2	Supported interfaces	Debuggin port	Support USB TYPE-C	
		Serial port	Support RS485	
		Ethernet port	Support 3 10/100M self-adapted port; 1 WAN port, 2 LAN ports	
		SIM card	Support 1 SIM card	
		Antenna	Support 1 SMA antenna	
3	Indicator light	Power indicator, Internet status, running status, signal indicator		
4	Power supply range	DC 10V-24V		
5	Power consumption	<5W		
6	Temperature range	-25~+65 ° C (-13~+149 ° F)		
7	Protection class	IP20		
8	Installation mode	Rail and wall mounting		
9	Remotor monitor	Support 01/02/03/04 function code, default baud		
		Support 01/02/03/04 function code, default IP 192.168.1.100, port 502		
	Remote upgrade	Firmware upgrade		
		Strategy file upgrade		
	Multi-Internet	Serial port: virtual port transparent		
		Ethernet: VPN transparent		
VPN transparent	4G, Etherent			
4G modem	Convenient for remote debugging			
Switch	Change public LTE wireless Internet into wire Internet			
		Two LAN ports support switch function		

No.	Functional classification	ICA413 series specification		
1	Supported networks	Support TDD-LTE, FDD LTE		
		Backward compatible with HSPA+, EVDO, GPRS, CDMA networks		
2	4G network rate	In the case of unstable 4G network coverage, it can be smoothly backward compatible to ensure uninterrupted data		
3	Supported interfaces	10Mbps (downstream) /5Mbps (upstream)@CAT1		
		1 standard RS485 interface		
4	Indicator light	1 standard RJ45 Ethernet port (10/100M)		
		Power indicator, network status light, operating status light		
5	Power supply range	DC 10V-24V		
6	Power consumption	<5W		
7	Temperature range	-25~+75 ° C		
8	Protection class	IP20		
9	Installation mode	Rail mounting		
10	Function	Support IP and PORT client tool configuration		
		Support ARP, Ethernet, MODBUS, MQTT, FTP protocol		
		Support OTA remote upgrade		
		Remotely query system status, network connection status, signal strength, etc		

IWOCloud industrial cloud platform

The industrial Internet of Things (IoT) data processing platform built by INVT provides a stable, secure and efficient basic platform for various IoT industries and application scenarios; as the "brain" of the IoT system: it provides the ability to meet the large-scale data terminal node access and high concurrent terminal access, and data reception, cleaning, collation, distribution and storage for data uploaded by various devices; at the same time, it provides a database interface that provides a standard unified data format to meet the characteristics of the continuous development of enterprise informatization.

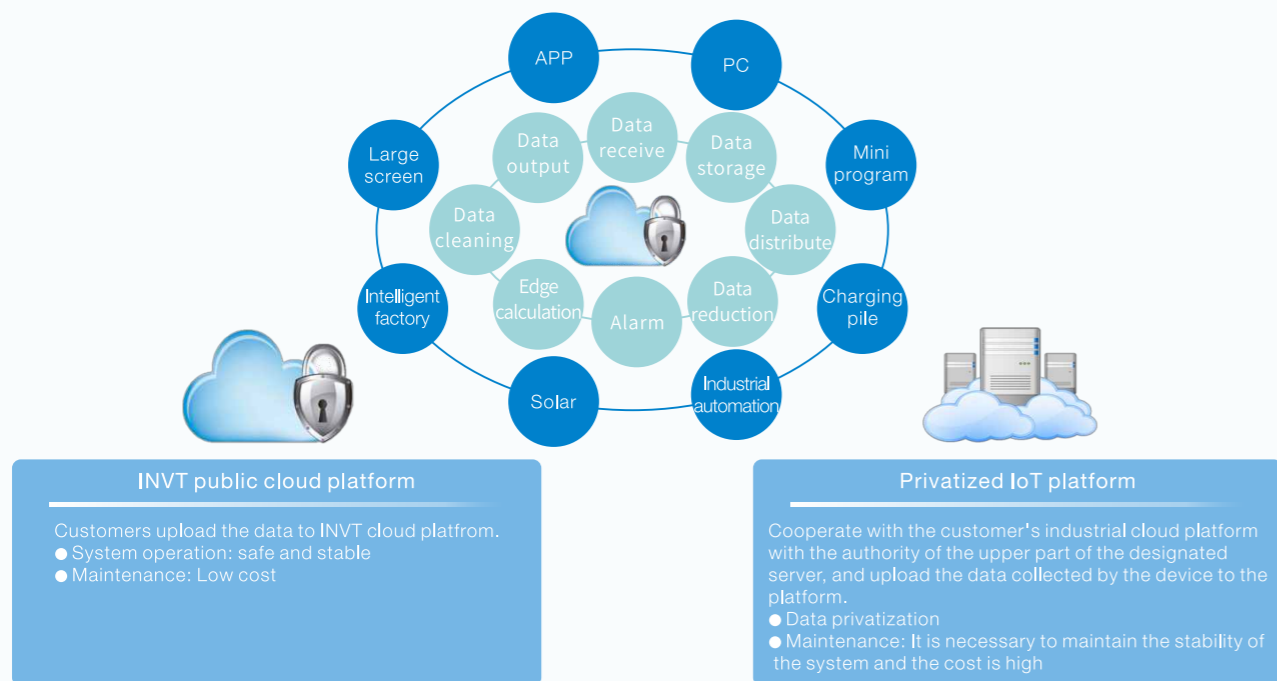

Industrial cloud services

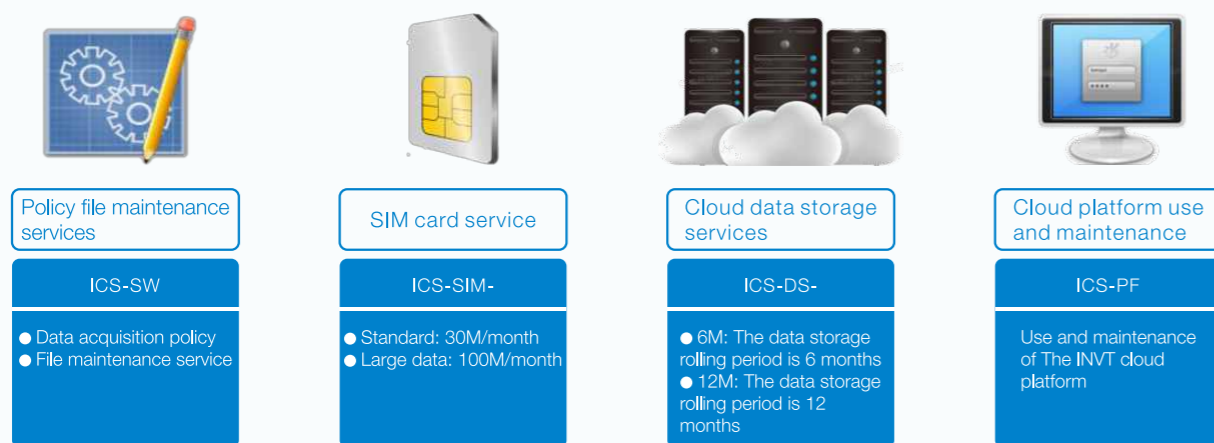

Policy file maintenance service

- ICS-SW: Data acquisition policy file maintenance service to upgrade and update different data points of the devices.

SIM card service

- Standard: 30M/month
- Large data: 100M/month

Cloud data storage services

- 6M: The data storage rolling period is 6 months
- 12M: The data storage rolling period is 12 months

API interface service

- ICS-API: The third-party system platform can obtain real-time data of the device, remote control of the device, and remote upgrade of the program
- Standard version: The business application system provides an API data interface for data calls by third-party systems
- Customized version: The data interface can be customized according to the requirements of third-party systems

Cloud platform use and maintenance

- ICS-PF: use and maintenance of INVT industrial Internet Cloud Platform

Typical industry solutions

● Air compressor Internet of Things integrated service management platform

● System Introduction

Based on more than ten years of technology and industry knowledge accumulation in the industry, INVT has created a set of integrated service management platform for the Internet of Things applied to the general IoT industry, integrating equipment monitoring, equipment management, report analysis, and equipment reverse control, and is committed to solving various management problems caused by the complex equipment suppliers and poor use environment in the air compressor industry, creating a more relaxed and efficient equipment management and operation experience!

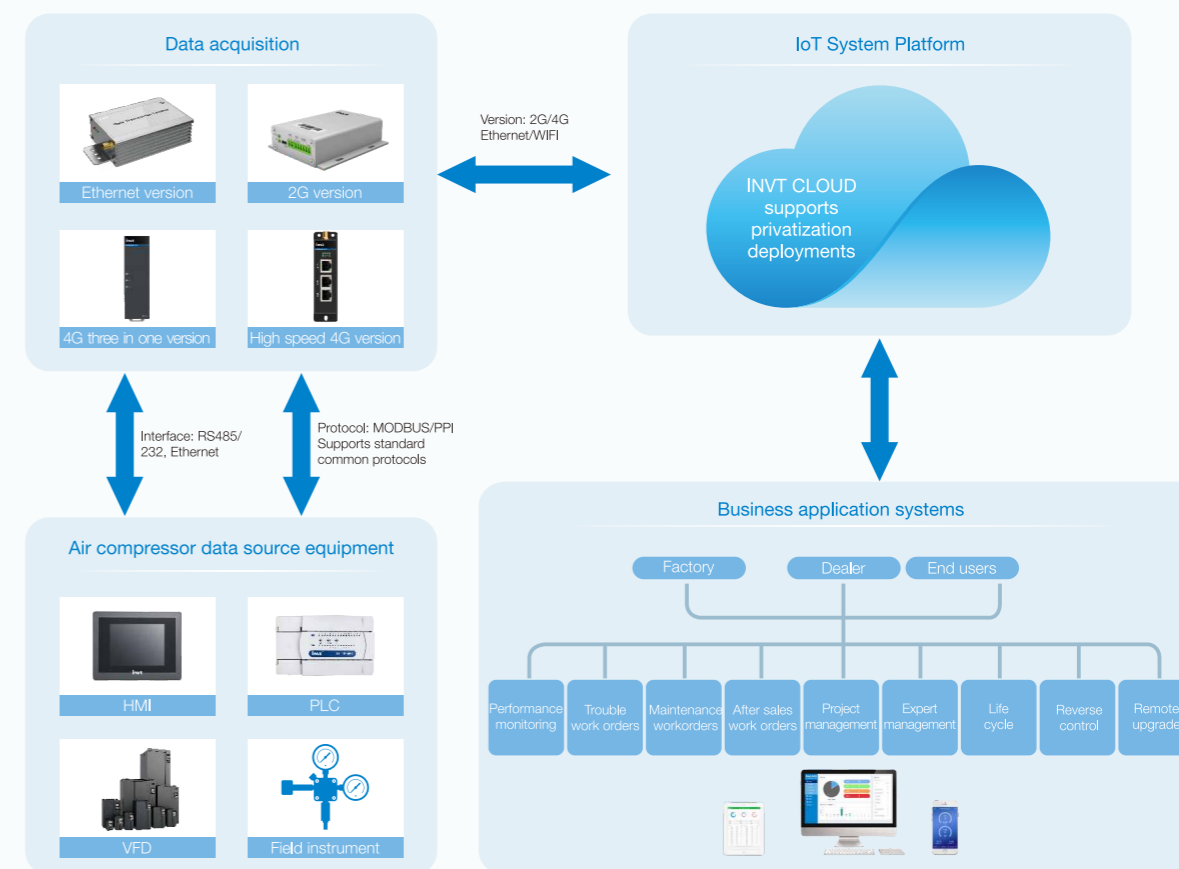

INVT IoT architecture diagram

● Equipment manufacturer

1. Fault work order: timely and accurate handling of faults to improve user experience.
2. After-sales work order: remote after-sales, remote control, improve after-sales efficiency.
3. Maintenance work order: actively trigger maintenance tasks, enhance customer stickiness, and drive the sales of original parts.
4. Expert knowledge base: accurate fault handling suggestions push to help efficient processing.

● Equipment service providers

1. Full life cycle management: all data of the equipment are fully recorded, and from then on the machine also has a "medical record book".
2. Maintenance work order: increase customer stickiness, increase the income of the service market.
3. Equipment/customer management: The same platform realizes management information, easy and efficient office experience.

● End users

1. Real-time attention to the monitoring of equipment efficiency and efficiency, pay attention to energy saving and efficiency: gas-to-electricity ratio, dynamic rate, characteristic curve, energy consumption curve, efficiency curve, etc.
2. Full life cycle management: all data of the equipment are recorded, and from then on the machine also has a "medical record book".
3. Data report management: automatically collect data, various reports can be customized and automatically generated and output.

● Construction Machinery Internet of Things Intelligent Management Platform - Security priority

As special equipment, construction machinery always takes safety in the first place. For the construction machinery equipment market manufactures and end users, INVT tailors the Internet of Things solution from the needs of the real use scenarios.



● Reverse control

The system provides authorized administrators who can remotely upgrade device programs and remotely lock the machine (this function adjusts the operation authorization mechanism according to the actual situation of customers).

● System parameter alerts

The system reports alarms on the settings of the key parameters (such as wind speed and load bearing) to secure the onsite safe production.

● Electronic fences

The system automatically monitors device location information through GPS. Once the location exceeds the predefined area, the system sends an alert.

● Device remote monitoring

Real-time equipment status monitoring, key-parameter limit exceeding alarm, positioning module, onsite video surveillance system that can connect to the IoT platform when necessary.

● User usage behavior analysis

For key parameters, the system provides custom data query function, which supports the display of 5 historical data curves on the same axis, which is convenient for on-site fault traceability and accident responsibility.

● Customer management

Provide lease expiration reminders for customer management in the rental market.

● Solar water pump IoT intelligent platform - more than just remote monitoring

INVT solar water pump Internet of Things monitoring system is a set of Internet of Things monitoring, management and analysis system applied to the photovoltaic pump industry, for manufacturers and direct users, to solve the photovoltaic pump industry due to the location of the equipment is remote, scattered and other caused by the management and maintenance difficulties, so that the work is more intelligent and more efficient.

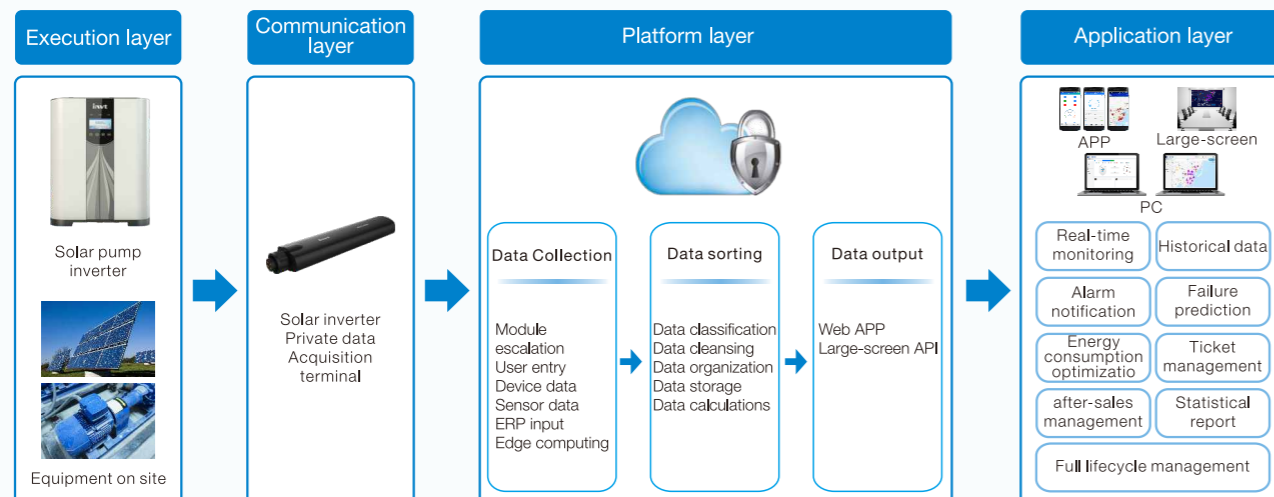

● The system automatically inspects and checks, away from waste of human resources

For the key indicators of equipment operation, the time period of automatic patrol inspection can be set and the patrol inspection report can be formed.

● Parameter early warning, strategic planning

For the key parameters, an early warning trigger threshold can be set, and once the parameters are abnormal, the system issues an early warning message, and the manager decides whether it is necessary to trigger the work order processing.

● Reverse control

The start-stop of the solar pump system can be controlled remotely via a computer, mobile phone or tablet.

● Fault management, so that things are "well documented"

Real-time monitoring of equipment status, equipment abnormality system trigger system alarm prompts, you can notify the manager through mobile APP, SMS, email, etc., and trigger the fault work order, so as to achieve full tracking of the fault handling process and full recording of the processing results.

● Data analysis to aid decision-making

For equipment maintenance, engineers refer to the fault management system and early warning system to remotely analyze the fault, narrow the scope of the problem, prepare solutions in advance, improve work efficiency and save costs.

● Smart Factory Solutions (-Energy Saving, Emission Reduction, Production Enhancement and Efficiency)

The smart factory solution is a digital factory and a product from demand to design, production, operation, maintenance and other full life cycle management system. Its purpose is to summarize and integrate the manufacturing data, operation data, maintenance data, etc. of the equipment, and then analyze and process the data through the big data analysis system and artificial intelligence system, and finally complete the optimization design of the product, the improvement of production capacity, efficient operation, remote pre-maintenance and other effects.

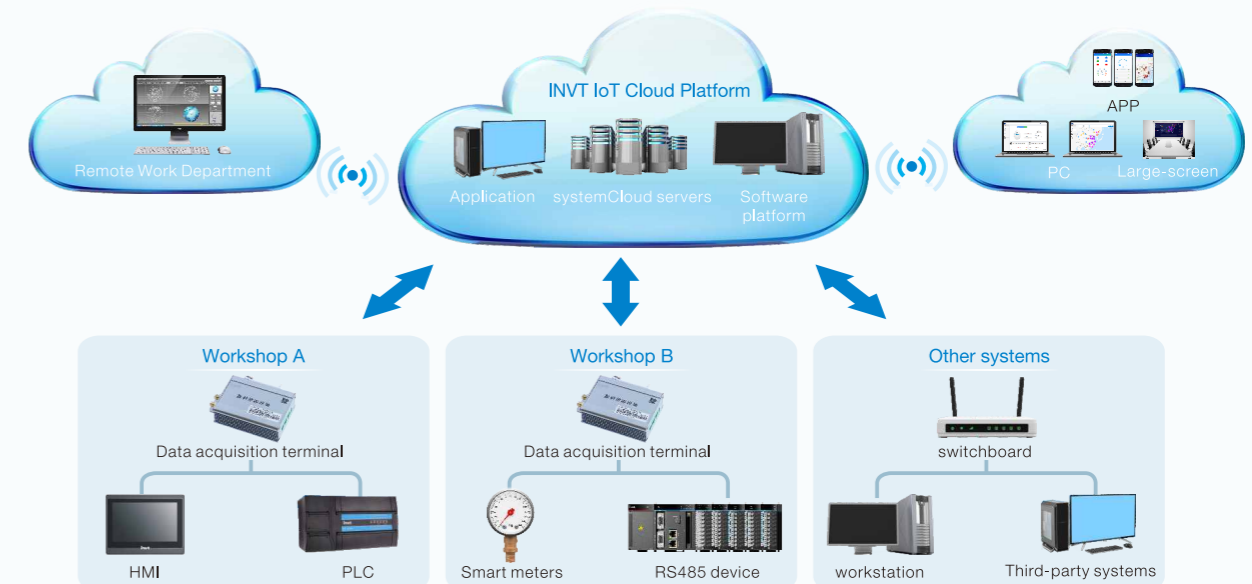

In view of the goal of energy saving, emission reduction, production and efficiency increase in smart factories, INVT IoT solutions will be gradually realized in three stages:

1. Realize the interconnection and interoperability of various industrial equipment data in the factory;
2. Management of energy consumption and fault of factory equipment;
3. Borrow data analysis to establish a mathematical model of equipment energy saving and emission reduction, production and efficiency increase.

● Phase I

- 1) Equipment management: The production equipment management and test equipment on the production line are added, deleted, and checked.
- 2) Collection management: the factory collector management, the collector is responsible for collecting production equipment, energy consumption equipment data and uploaded to the cloud platform server through Ethernet.
- 3) Video surveillance: Call the video URL to display the video image through the network.
- 4) Large-screen monitoring: Displays various statistical data charts such as the status of factory production equipment and energy consumption.

● Phase II

- 1) Factory production line management: For factory production line management, only super admin users have this function module.
- 2) Equipment energy consumption management: the energy consumption management of factory equipment, to achieve the function of adding, deleting, modifying and checking.
- 3) System management: manage system users and permissions. Including user additions, deletions and modifications and user pairs should be controlled by permissions. Permissions are used to accurately control the management of the module by checking the box.

● Phase III

- 1) Big data analysis: Mathematical modeling of business modules, using big data technology for analysis and statistical processing.
- 2) Artificial intelligence: On the basis of big data analysis, AI technology is used for further intelligent processing to achieve predictive maintenance, equipment use strategy optimization and other scenarios.

Marketing service network

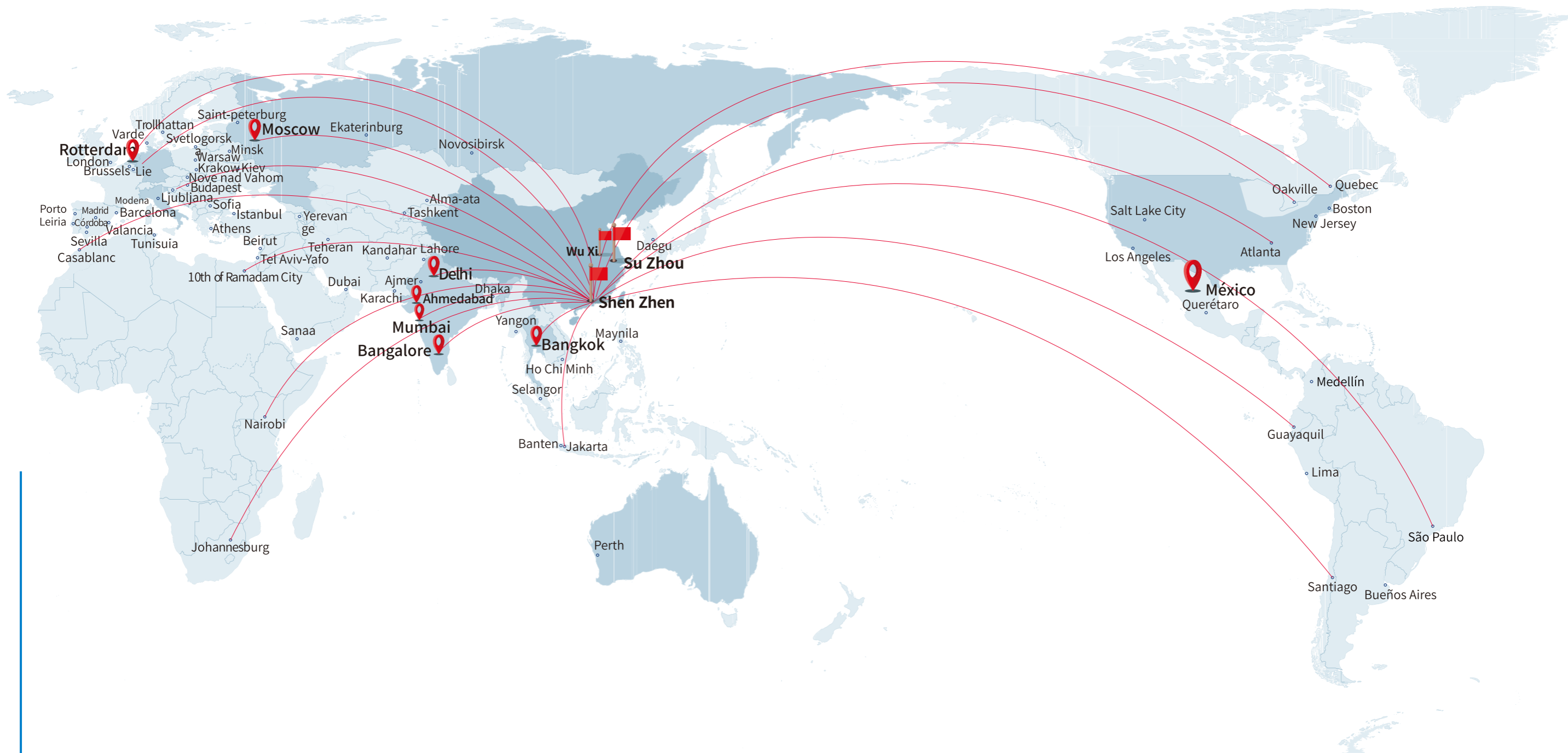

INVT Factory * 3

INVT Headquarter in Shenzhen

INVT Overseas Subsidiaries and office * 8

More than 100 Overseas Partners

